

## About This Guide

Thank you for choosing this Gigabit Color IP Phone which is especially designed for power users in the office environment. It features fashionable and sleek design, abundant telephony applications, broad interoperability with the popular 3<sup>rd</sup> party VoIP products, fulfilling the VoIP deployment needs from enterprise and ITSP.

In this User Guide, you will find everything you need to quickly use your new phone. Be sure to verify with your system administrator that your network is prepared for configuring your IP phone. As well, be sure to read the Packing List section in this guide before you set up and use the phone.

### Declaration of Conformity



Hereby, it's declared that this phone is in conformity with the essential requirements and other relevant provisions of the CE, FCC.

### CE Mark Warning

This is a class B device, in a domestic environment; this product may cause radio interference, in which case the user may be required to take adequate measures.

### WEEE Warning



To avoid the potential effects on the environment and human health as a result of the presence of hazardous substances in electrical and electronic equipment, end users of electrical and electronic equipment should understand the meaning of the crossed-out wheeled bin symbol. Do not dispose of WEEE as unsorted municipal waste and have to collect such WEEE separately.

# Contents

## Getting Started..... - 6 -

Packing List .....	- 6 -
Assembling the Phone.....	- 8 -
Configuration and Registration .....	- 10 -
Configuring via Web Page .....	- 10 -
Configuring via keypad.....	- 11 -

## Overview..... - 12 -

Keypad Instruction.....	- 12 -
LED Instruction.....	- 14 -
Icon Instruction .....	- 15 -

## Customizing Your Phone..... - 17 -

Idle interface .....	- 17 -
Menu introduction.....	- 18 -
Status.....	- 19 -
Features .....	- 21 -
Call Forward .....	- 21 -
Call Waiting .....	- 22 -
DSS Keys .....	- 24 -
Key as Send.....	- 25 -
Hot Line .....	- 26 -
Anonymous Call .....	- 27 -
Auto Redial .....	- 29 -
DND Code.....	- 30 -
Intercom .....	- 31 -
Call Completion .....	- 33 -
Broadsoft Settings menu .....	- 34 -
History Setting .....	- 36 -
Directory .....	- 37 -
Local Directory .....	- 37 -
Blacklist .....	- 45 -
Remote Phonebook .....	- 45 -
Broadsoft.....	- 47 -
LDAP .....	- 47 -
History.....	- 48 -
Local History.....	- 48 -
Network CallLog.....	- 49 -
Messages .....	- 49 -
Voicemail .....	- 49 -

SMS.....	- 52 -
Setting .....	- 56 -
Basic Settings.....	- 56 -
Advanced Settings.....	- 62 -
Display .....	- 75 -
WallPaper.....	- 75 -
Screensaver .....	- 76 -
Theme .....	- 77 -
Backlight.....	- 79 -
Applications .....	- 80 -
Digital Photo Frame .....	- 80 -
Other Settings.....	- 81 -
Codec Selection.....	- 81 -
Auto Answer .....	- 81 -
Missed call log .....	- 82 -
Programmable Key .....	- 82 -
Softkey Layout.....	- 82 -
Live Dialpad.....	- 83 -
Dial Plan.....	- 84 -
Feature Synchronisation.....	- 86 -
WatchDog.....	- 86 -
Action URL/URI.....	- 86 -
XML-IdleScreen .....	- 89 -

## **Using the Basic Call Functions..... - 90 -**

Making a call.....	- 90 -
Call Devices .....	- 90 -
Call Methods.....	- 90 -
Answering a call.....	- 92 -
Answering an incoming call.....	- 92 -
Denying an incoming call .....	- 92 -
DND.....	- 93 -
Call Forward .....	- 93 -
During an Active Call .....	- 94 -
Mute .....	- 94 -
Call Hold.....	- 94 -
Call Waiting .....	- 95 -
Call Transfer.....	- 95 -
Local Conference .....	- 96 -
Network Conference .....	- 97 -

## **Using the Advanced Phone Functions ..... - 98 -**

Account Settings .....	- 98 -
TLS .....	- 99 -

DNS-SRV .....	- 100 -
Network Setting .....	- 100 -
LLDP.....	- 100 -
Maintenance Tasks .....	- 101 -
Administrator Mode.....	- 101 -
Administrator/User Password .....	- 102 -
Reboot.....	- 102 -
Reset to Factory .....	- 102 -
Firmware Update.....	- 102 -
Export / Import Config.....	- 104 -
System Log Export.....	- 104 -
PCAP Trace Export.....	- 104 -
Zero-sp-touch.....	- 105 -
DSS key Configuration .....	- 106 -
Line .....	- 107 -
Speed Dial.....	- 107 -
BLF .....	- 107 -
BLF List .....	- 108 -
Voice Mail.....	- 108 -
Pick Up.....	- 108 -
Group Pick up .....	- 108 -
Call Park.....	- 109 -
Intercom .....	- 109 -
DTMF .....	- 110 -
Prefix.....	- 110 -
Local Group .....	- 110 -
XML Group.....	- 110 -
LDAP.....	- 111 -
Broadsoft Group.....	- 111 -
Conference .....	- 111 -
Forward .....	- 112 -
Transfer .....	- 112 -
Hold.....	- 112 -
DND.....	- 112 -
Redial .....	- 113 -
Call Return .....	- 113 -
SMS.....	- 113 -
Record.....	- 113 -
URL Record .....	- 114 -
Paging .....	- 114 -
Group Listening .....	- 115 -
Public Hold .....	- 115 -
Private Hold .....	- 115 -
Shared Line .....	- 115 -

ACD.....	- 116 -
Zero-sp-touch.....	- 116 -
URL.....	- 117 -
Voice.....	- 117 -
Ring.....	- 118 -
Tone Settings.....	- 119 -
<b>Trouble Shooting.....</b>	<b>- 121 -</b>

# Getting Started

## Packing List

The following components are included in your package:

- Gigabit Color IP Phone

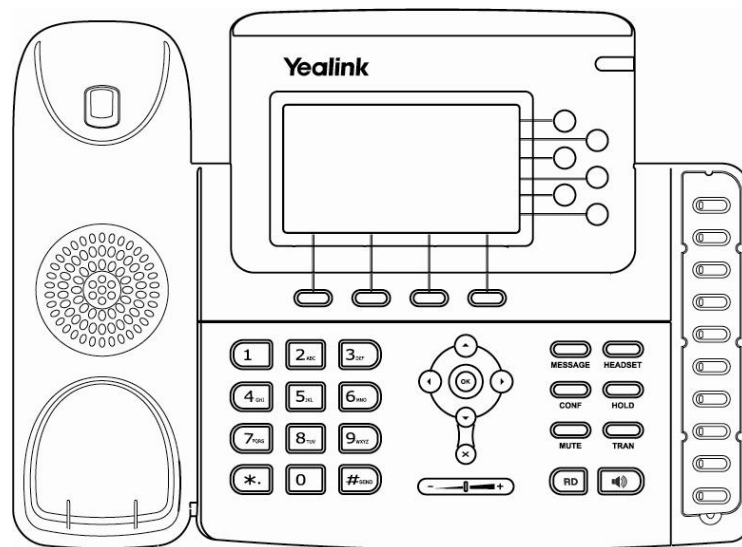

- Phone Stand

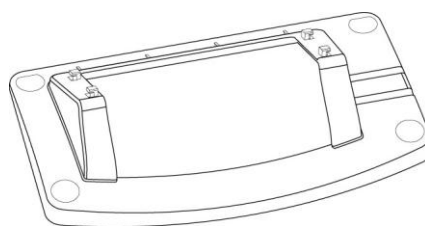

- Power Adapter

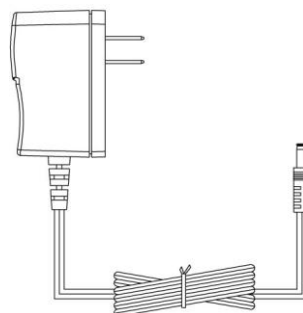

- Handset & Handset Cord

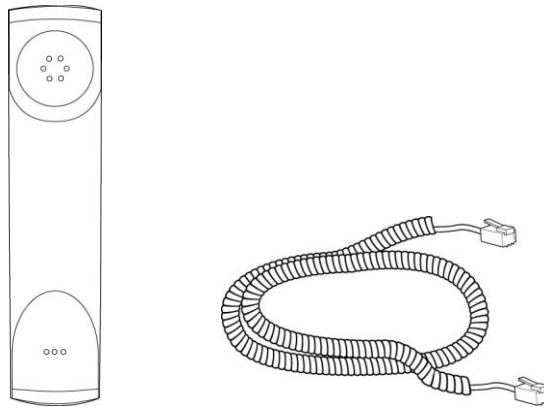

- Ethernet Cable

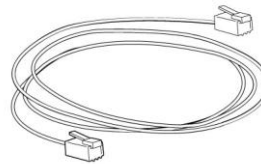

- Quick Installation & Quick Reference Guide

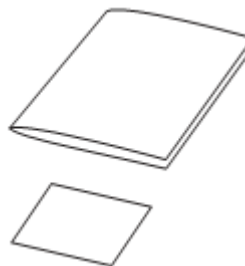

- CD Content



Check this list before installation to ensure that you have received each item. If you are missing any items, contact your IP phone reseller.

## Assembling the Phone

This section introduces how to assemble the phone with the components in the packing list:

- Attach the stand;
- Connect Handset and Headset;
- Connect Network and Power.

### 1) Attach the Stand, as shown below:

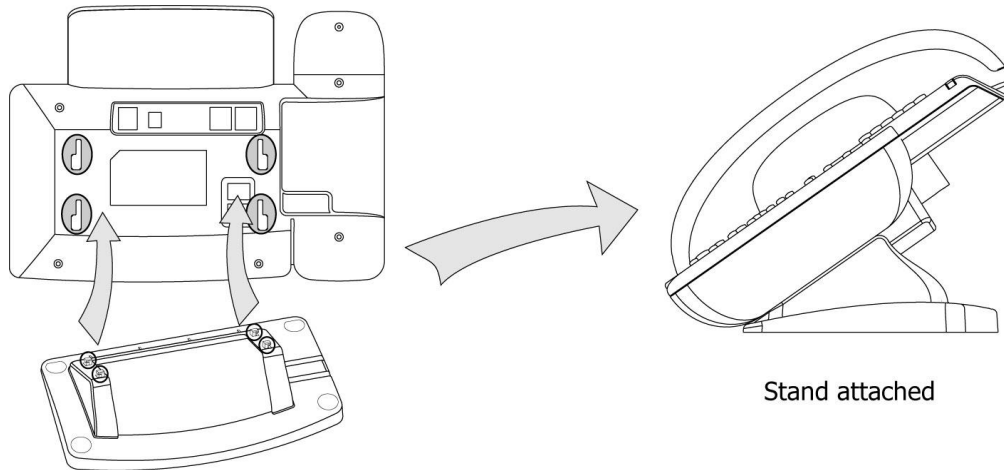

### 2) Connect Handset and Headset, as shown below:

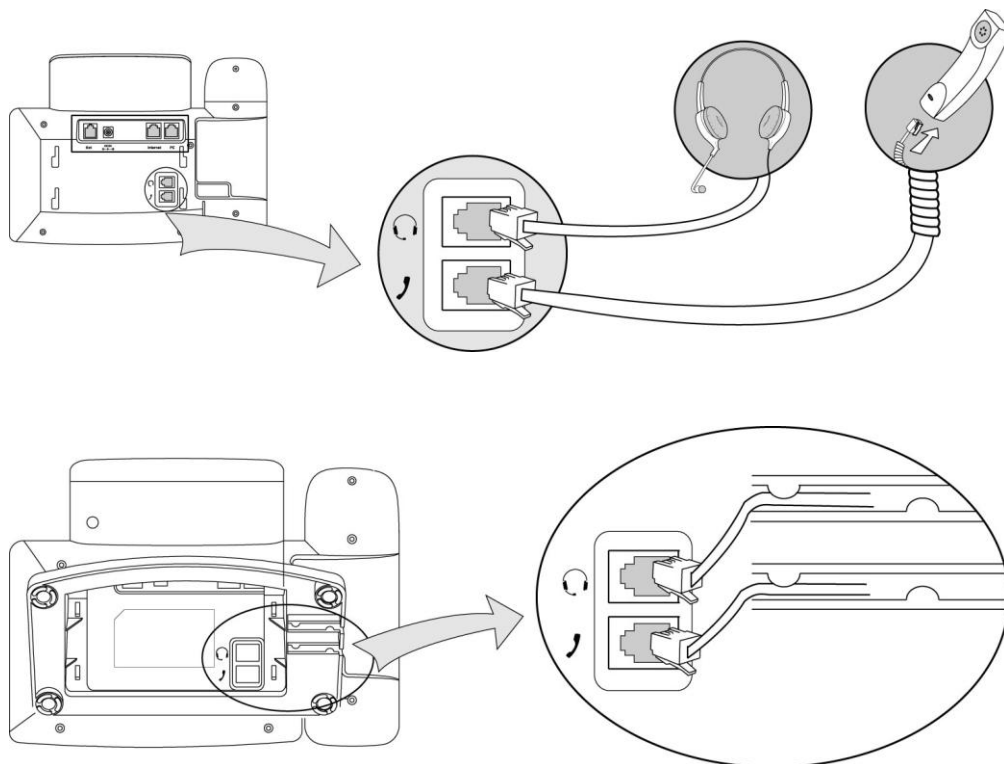

**Note:**



Headset is not provided in the packing list. Please contact your distributor for more information.

### 3) Connect Network and Power

There are two ways for network and power source connections. You can either connect the phone to the AC Power directly using the power adapter or to a PoE compliant switch or hub. Your system administrator will advise you on which one to use.

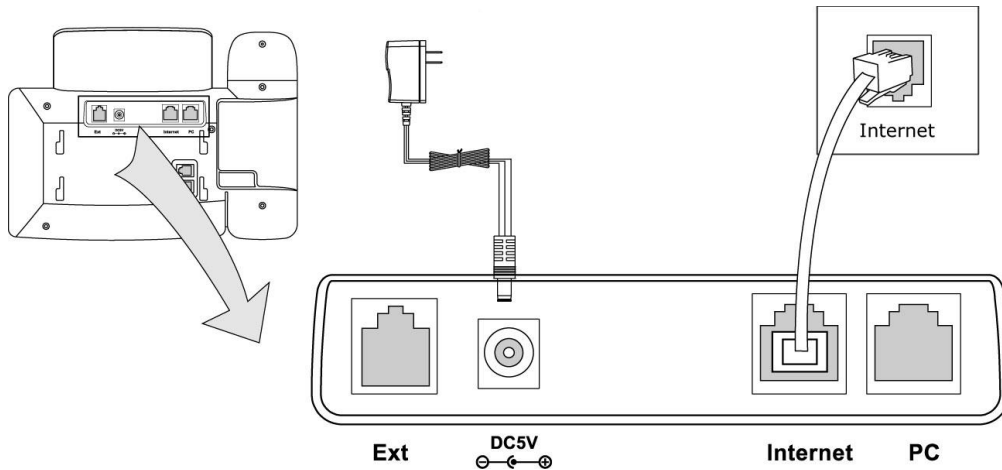

#### Note:

1. If inline power is provided, do not install AC adapter. Make sure the Ethernet cable and switch/hub is POE compliant.
2. The Internet Port can be also connected to Hub/Switch/IP PBX or other internet devices.
3. When the phone is powered by POE (Power Over Ethernet) at this situation, you have to use Power Adapter to support Expansion model if the phone is connected to an Expansion model.

The phone can also share the network connection with other network devices such as PC. Connect the phone's PC port and computer's Network Port together using an Ethernet cable, shown as below:

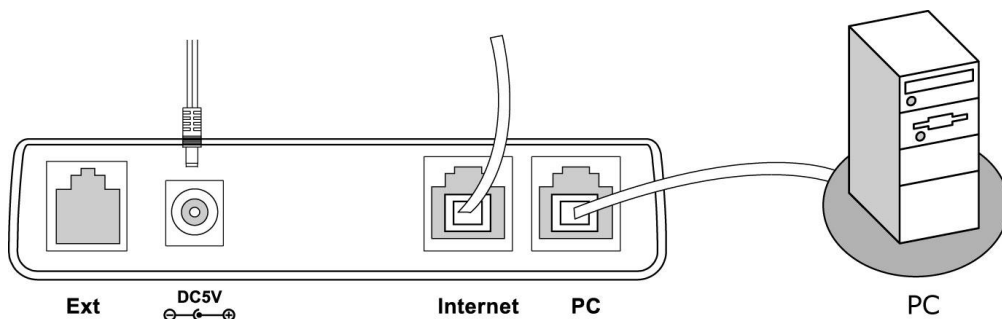

## Configuration and Registration

If you are administrator, you need to do some simple configuration to make the phone work. If not, please contact your internet administrator or service provider for more details.

### Configuring via Web Page

Press OK button on the keypad of the phone to enter the status page and find out the IP address of IP phone. Enter it (for example http://192.168.3.35) into the address bar of web browser. The default administrator's login name and password are **admin/admin**. The default user's login name and password are **user/user**.

**Note:**

Please locate your PC in the same network segment as your IP phone (192.168.3.X) to access the web configuration page. Please consult your system administrator for help.

### Network Settings

Choose Network->Basic->WAN

**DHCP:** Under the default situation the phone attempts to contact a DHCP Server in your network in order to obtain its valid network settings, e.g. IP address, subnet mask, gateway, DNS server, etc.

**Static IP Address:** If your phone cannot contact a DHCP Server for any reason, you need to enter the network settings manually via Static IP Address. Please contact your internet administrator for more details.

**PPPoE:** If you are using the xDSL Modem, you can connect your phone to the internet via PPPoE mode. Please contact your ISP for the User **Name** and **Password** for internet access.

**Note:**

Using the wrong network parameters may result in inaccessibility of your phone and may also have an impact on your network performance. Please contact your network administrator.

### Account Settings

The phone attempts to register to the SIP server using the account data provided by the automatic or manual initialization.

Choose Account->Basic->Account X, you will find the following parameters:

Field	Description
<i>Register Status</i>	It shows the register status of the phone.
<i>Account Active</i>	You can choose enable/disable the account respectively.
<i>Label</i>	The name showing on the LCD of current device.
<i>Display Name</i>	The local phone name showing on the other phone when calling.
<i>Register Name</i>	SIP service subscriber's ID used for authentication.

<i>User Name</i>	User account, provided by VoIP service provider.
<i>Password</i>	Account password provided by ISP.
<i>SIP Server</i>	SIP server address provided by ISP.

When you have finished the Network and Account Setting configuration, the Register Status Icons will show in the idle screen:



Registered successfully



Register failed



Registering

When there is not any account registered successfully, the phone will display "No Service" by default on the idle interface.

When the phone boots up, it will register all its accounts to server automatically. If many phones register at the same time, this will affect the server, the users can set the Registered random time on electricity so that the phone will random register automatically within the set time.

Setting the power up time via web interface:

Choose Network->Advanced->Registration random, enter the time in the field.

**Note:**

Should the IP PBX (SIP registrar) require an authentication, you will be prompted to enter the correct password. Make sure you are using the appropriate input method or enter the password via the web user interface.

## Configuring via keypad

**Network Settings:** Press Menu->Setting->Advanced Settings, enter the password, and choose Network ->WAN Port /PC Port /VLAN/Webserver Type/802.1x Settings/VPN Option to enter the network relating configuration page.

**Account Settings:** Press Menu->Settings->Advanced Settings, enter the password, and choose Accounts to configure the account settings.

You can refer to the above "Configuring via Web Page" for the parameter details.

# Overview

## Keypad Instruction

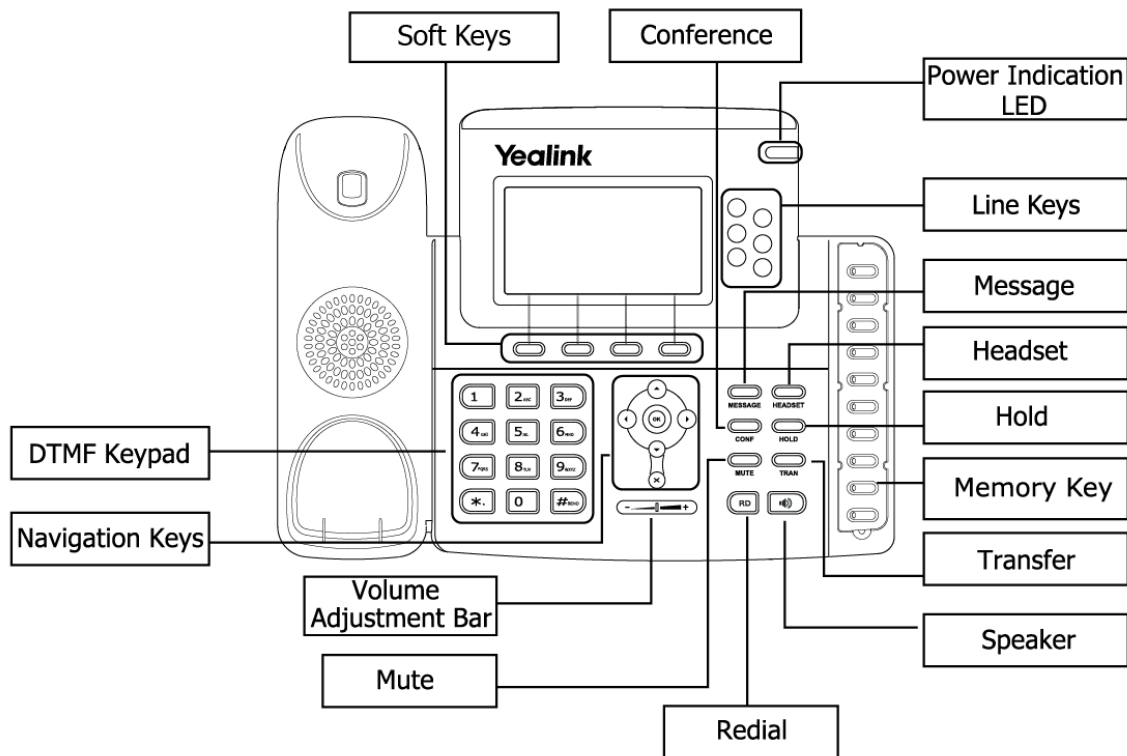

You can check the following list which introduces the IP phone's keypad in details:

### Power Indication LED

It will show the power status, it will be on if the phone is powered, off if the phone is not powered, and blink when there is an incoming call or there is a call on mute.

### Soft Keys

The screen will display labels for these keys, to identify their context-sensitive functions, and you can custom soft keys. To be different layout, you can refer to "[Softkey layout](#)" function for details.

### Line Keys

These buttons are used to active up to the six user accounts.

These keys are also used for various functionalities such as call /Line appearance Button.

### Memory Key

Memory key which is short for direct station select keys are used for various functionalities such as call /Line appearance Button, Speed dial, Intercom, Pickup, Hold, Transfer, etc.

### Dial Pad

Use the DTMF hard keys to enter numbers, letters and special characters. Depending on the selected input mode, you can enter digits, lower / upper case or special characters.

### Navigation Keys

Use the navigation keys to navigate in the display menus and confirm or cancel actions.

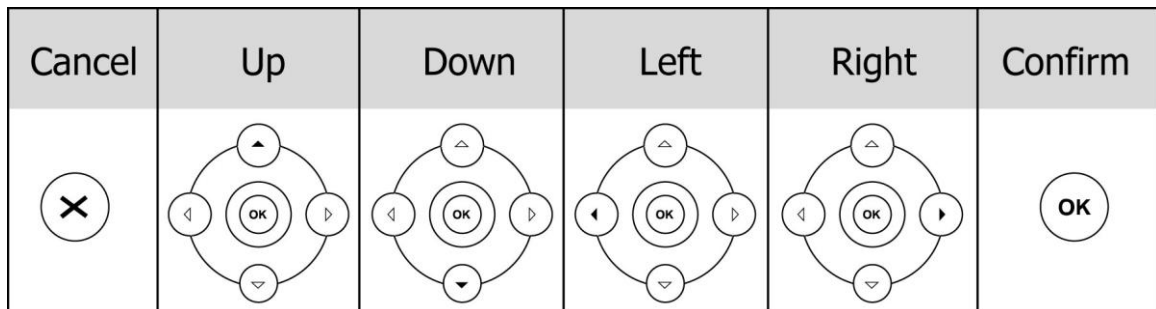



### Audio Device Control Keys

Use the audio device control keys to perform the following actions depending on your phone type:

 : Adjust the volume of the handset, headset, speaker, ring tone and signal tone;

 : Allows for hands-free communication during calls;  
Press to switch to the Group Listening mode;

 : Place and receive calls through an optionally connected headset. The LED will be on when the phone is in Headset mode;

 : Mute audio transmission locally during calls;

### Hard Feature Keys

 : Allow users to access the voicemail interface directly;

 : Enable setup of a conference;

 : Place a call on hold or resume it;

 : During a call, press to transfer the current call to the third party;  
When the phone under the idle, press to enter the forward configuration page;



: Press to enter the Dialed Calls interface and choose a record to dial out;

## LED Instruction

Table 1 Memory Key set to BLF

LED Status	Description
Steady green	The monitored account is active
Blinking red	There is an incoming call to the monitored account
Steady red	The monitored account is on a conversation
Off	It is not active as BLF

Table 2 Memory Key set to BLA (Bridged Line Appearances)

LED Status	Description
Steady green	All of the members are in idle status
Steady red	Some part(s) is seizing the line
Blinking green 300ms□	Some part(s) is ring-back
Blinking red 300ms□	Some part(s) is ringing
Steady orange □	Some part(s) is on the phone
Blinking Orange 500ms□	Some part(s) is under the public hold status, and all of the members can retrieve the call
Blinking green 500ms	Some part(s) is under the private hold status, and only the initiator can retrieve the call
Blinking red 500ms□	Three way conference, all of the parts press hold
Off □	It is not active as BLA

Table 3 Line Keys set to BLF

LED Status	Description
Steady green	The monitored account is in idle status
Fast blinking green	There is an incoming call to the monitored account
Slow blinking green	The monitored account is on an conversation
Off	It is not active as BLF

Table 4 Line Keys set to BLA

LED Status	Description
Steady green	All of the members are in idle status
Slow blinking green	Some part(s) is seizing the line/ ring-back/ under the private hold status.
Fast blinking green	Some part(s) is ringing/on the phone / under the public hold status or all of the parts press hold.
Off	It is not active as BLA

Table 5 Line Keys

LED Status	Description
Steady green	The account is active

















Blinking green	There is an incoming call to the account, or there is a call on hold.
Off	The phone is in idle status whatever registered /unregistered











Table 6 Power Indication LED

LED Status	Description
Steady green	Power on
Blinking green	There is an incoming call, or there is a call on mute
Off	Power off







## Icon Instruction

The IP Phone displays different kinds of icons on its LCD, you can refer to the following table for their meanings:

Icon	Description
	Flashes when the internet is disconnected
	Account register failed
	Account registering
	Account register successful
	Missed calls in idle status
	In history page: Call in
	In history page: Call out
	In history page: Missed call
2aB	Input Method: all letters and numbers
123	Input Method: numbers
abc	Input Method: multi-lingual letters in lower case
ABC	Input Method: multi-lingual letters in upper case
	Call mute
	Call hold
	Voicemail
	SMS
	Call forward
	DND(Do Not Disturb)
	Auto answer
	In handset mode
	In headset mode

	In speaker mode
	Ring volume is 0
	The recording session cannot be started
	The recording cannot be stopped
	Probably the recording box is full
	This call cannot be recorded
	Enable the record function
	Open VPN
	Enable keypad lock
	Conference
	The default contact photo

User can set the line key as other function, for more information you can refer to "[DSS Keys](#)". Set the line key as corresponding function the corresponding icon will display on the line key label.

Line key ICON	Description
	The default icon when you set the line key as other function(except Line, BLF, Speed Dial, Record and XML Group).
	Set as BLF function, and the monitored account is Unregistered.
	Set as BLF function, the monitored account is in the idle.
	Set as BLF function, there is an incoming call to the monitored account.
	Set as BLF function, the monitored account is on a conversation.
	Set as Speed dial function.
	Set as XML Group function.



# Customizing Your Phone

## Idle interface

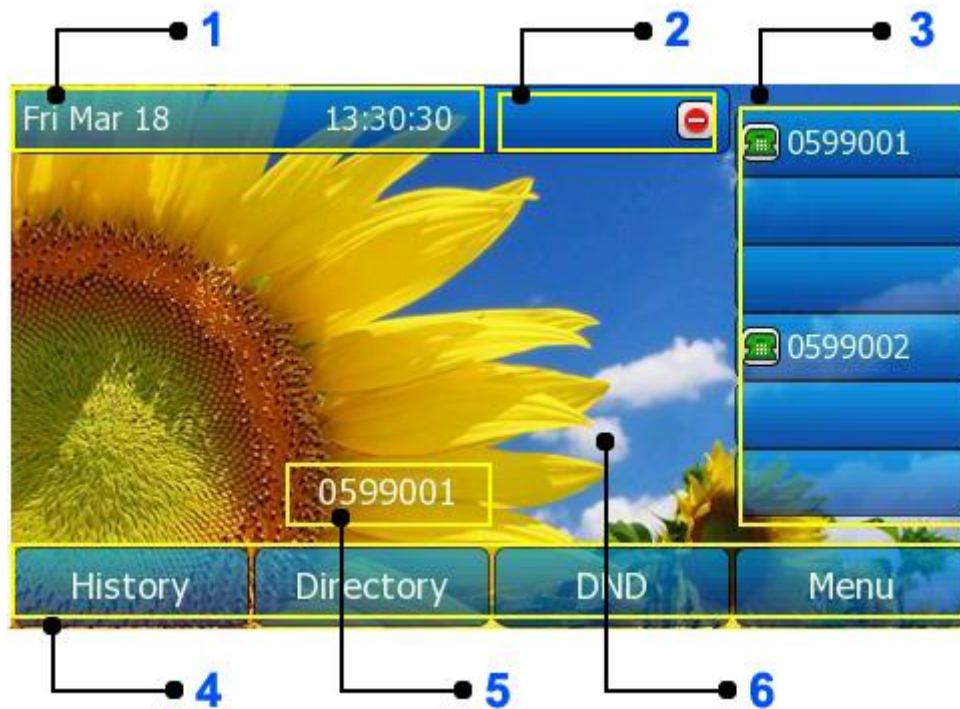

NO.	Description
1	This area is showing the phone's time.
2	This area is showing the phone feature status. For more information you can refer to " <a href="#">Icon Instruction</a> ".
3	This area is showing the six line key labels. You also can custom the line key as other function. For more information you can refer to " <a href="#">DSS Keys</a> ".
4	This area is showing the soft key labels. The screen will display labels for these keys, the default soft key 1-4 are "History", "Directory", "DND" and "Menu". User also can custom these soft key. For more information you can refer to " <a href="#">Softkey Layout</a> ".
5	This area is showing the default account. User can use Left/Right navigation key to choose the default account.
6	This area is showing the backgrounds picture. User also can change it. For more information you can refer to " <a href="#">WallPaper</a> ".

## Menu introduction

Enter into the main menu interface, there are some sub-menu, user can choose corresponding submenu to enter into the configuration interface.



Menu	Submenu	Second level submenu
Status	IP	----
	MAC	
	Firmware	
	More...	<ul style="list-style-type: none"> <li>• Network</li> <li>• Phone</li> <li>• Accounts</li> </ul>
Features	Call Forward	<ul style="list-style-type: none"> <li>• Always Forward</li> <li>• Busy Forward</li> <li>• No Answer Forward</li> </ul>
	Call Waiting	----
	DSS Keys	<ul style="list-style-type: none"> <li>• Line keys as DSS keys</li> <li>• Memory Keys as DSS Keys</li> </ul>
	Key as Send	----
	Hot Line	
	Anonymous Call	
	Auto Redial	
	DND Code	
	Intercom	
	Call Completion	
	Broadsoft Settings Menu	<ul style="list-style-type: none"> <li>• Broadsoft Dir Settings</li> <li>• CallLog Settings</li> </ul>
History Setting	----	
Directory	Local Directory	<ul style="list-style-type: none"> <li>• Contacts Group</li> </ul>

	Blacklist	----
	Remote Phonebook	• Contacts Group
	Broadsoft	• Contacts Group
History	Local History	----
	Network CallLog	• CallLog Group
Messages	Voice Mail	• View Voice Mail • Set Voice Mail
	Text Message	• New Message • Inbox • Sentbox • Outbox • Drafbox
Setting	Basic Settings	• Language • Time & Date • Time & Date Format • DHCP Time • Ring Tone
	Advanced Settings	• Accounts • Network • Phone Setting • Reset to factory • Set Password • Set AES Key • Auto Provision
Display	WallPaper	----
	Screensaver	
	Theme	
	Backlight	
App	Digital Phone Frame	

Note:

"----" is representative there is no second level submenu.

## Status

You can view the status of your phone using the Phone interface or the Web interface.

This option allows you to review:

- Network status: IP, Mac, WAN/LAN, Gateway and DNS etc.
- Phone status: Model, Hardware, Firmware, Product ID and MAC;
- Accounts: The 6 SIP accounts status;

To check the Phone Status via Phone interface:

- 1) Press Menu soft key, choose the Status option, or press OK button on the idle

interface.

- 2) User can check the IP address, MAC and firmware directly.
- 3) If you want to check more information, you can Use the Up/Down navigation keys choose "More" option, press enter soft key.
- 4) And then choose the specific one to check.



## Features

### Call Forward

This feature allows you to forward an incoming call to another phone number e.g. a cell phone or voice mailbox.

The following call forwarding events can be configured:

- *Always:* Incoming calls are immediately forwarded.
- *Busy:* Incoming calls are immediately forwarded when the phone is busy.
- *No Answer:* Incoming calls are forwarded when the phone is not answered after a specific period.

To configure Forward option via phone interface:

- 1) Press Menu->Features ->Call Forward to enter the configure page.
- 2) There are 3 options: Always Forward, Busy Forward and No Answer Forward.



- 3) If you choose one of them, enter the phone number you want to forward.
- 4) If you choose No Answer Forward, you must also choose "After Ring Times".
- 5) If you want to realize this function by server, please enter the On Code and Off Code option, then when you choose to enable the call forward function via your IP phone, it will send message to the server, and the server will turn on the function immediately. When there is call to the extension, the server will forward it to the set number automatically based on the forward type. And the IP phone will not show the record in the call history anymore.



6) Press Save soft key to save the changes.

To configure Call Forward via Web interface:

Choose Phone->Features->Forward to do the relating changes. Please refer the above configuration information.

## Call Waiting

This call feature allows your phone to accept any incoming calls to the extension under

all circumstances.

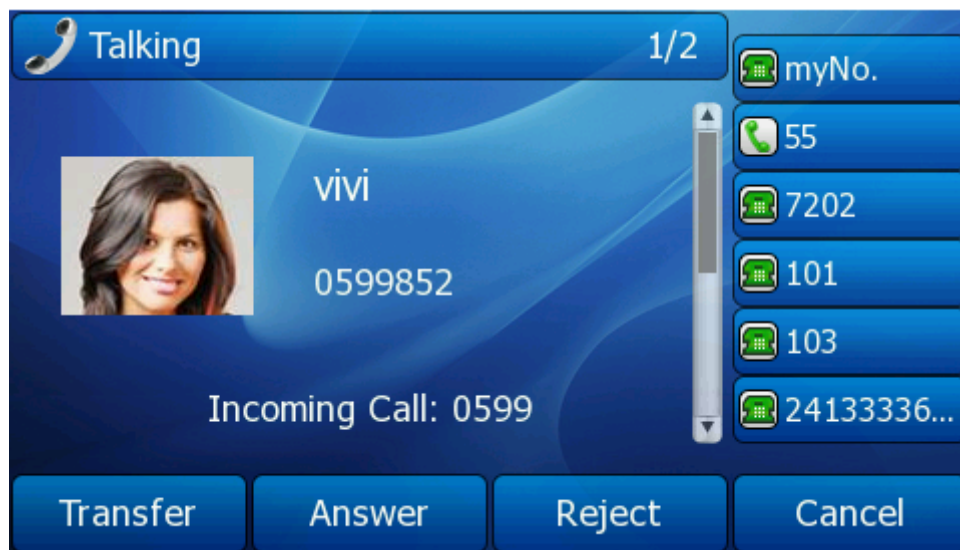

To enable/disable Call Waiting via Phone interface:

- 1) Press Menu->Features->Call Waiting.
- 2) Use the navigation keys or Switch soft key to enable/disable the call waiting option.

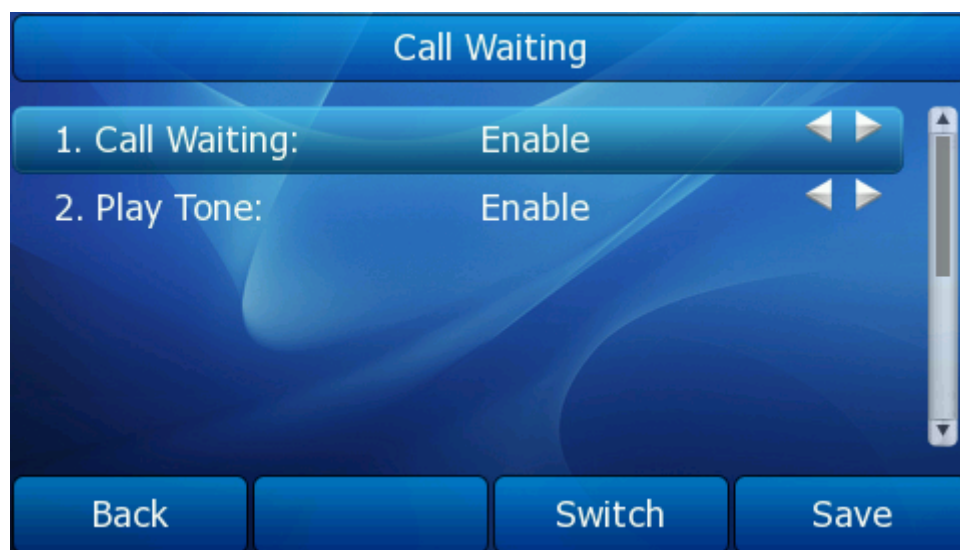

- 3) Use the navigation keys or Switch soft key to enable/disable the Play Tone option. This option used to define whether to play ring tones when there is call incoming during an active call.
- 4) Press Save soft key to save the changes, or Back to return to the previous menu.

To enable/disable Call Waiting via Web interface:

Choose Phone->Features->Call Waiting option to do the relating changes.

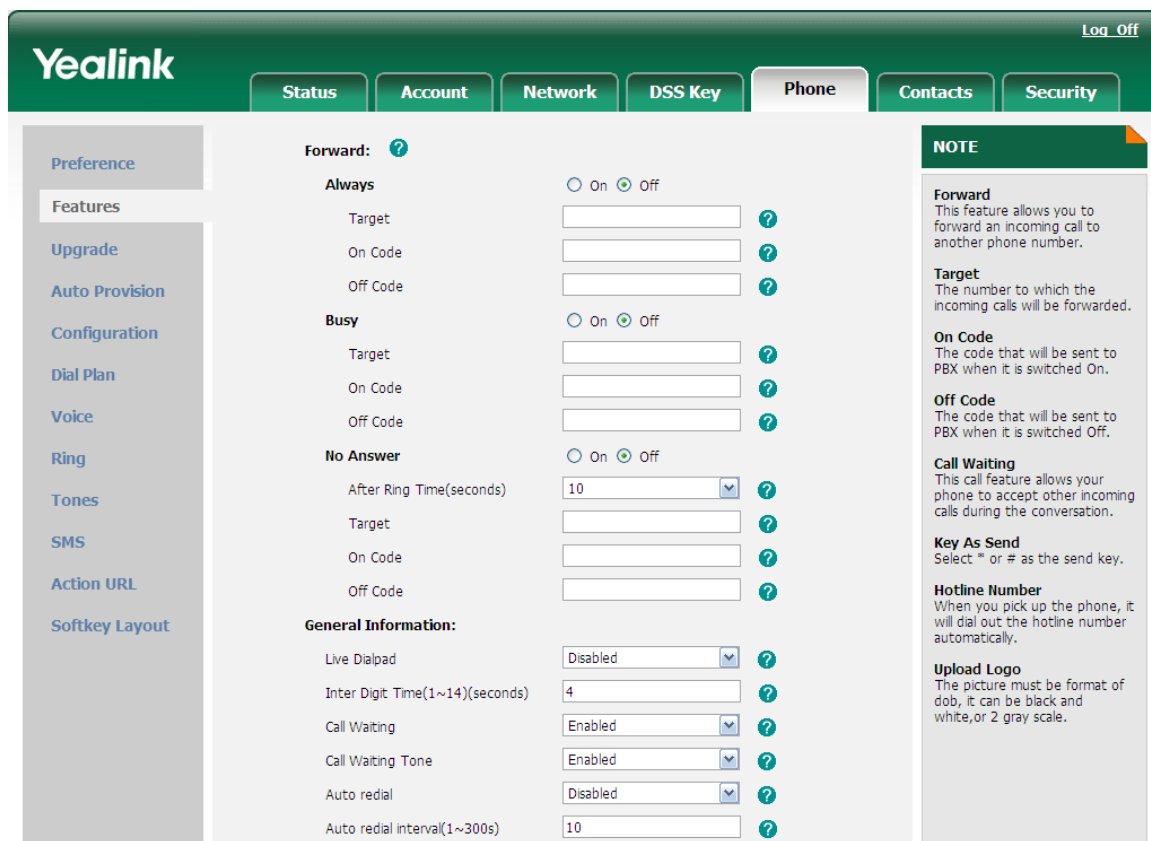

## DSS Keys

The phone has 10 Memory keys which are able to set up to 33 functions per key. And it has 6 line keys which are able to set up to 32 functions per key.

Set up DSS key via phone interface:

- 1) Press Menu->Features-> DSS keys enter into the configure page.
- 2) Choose one of the line (Memory) key you want to make the assignment.
- 3) Choose the type, and then configure the corresponding contents.





Set up DSS key via web interface:

- 1) Choose DSS Key->Memory Key or Line Key, choose one of the keys you want to make the assignment
- 2) Choose the type, and then configure the corresponding contents.

For more information about any function and operation procedure you can refer to "[DSS key Configuration](#)".

## Key as Send

Users can set a specific button ("#" or "\*") to active as the send button.

To set the send key via the IP phone interface:

- 1) Press Menu->Features->Key as Send to enter the configuration page.

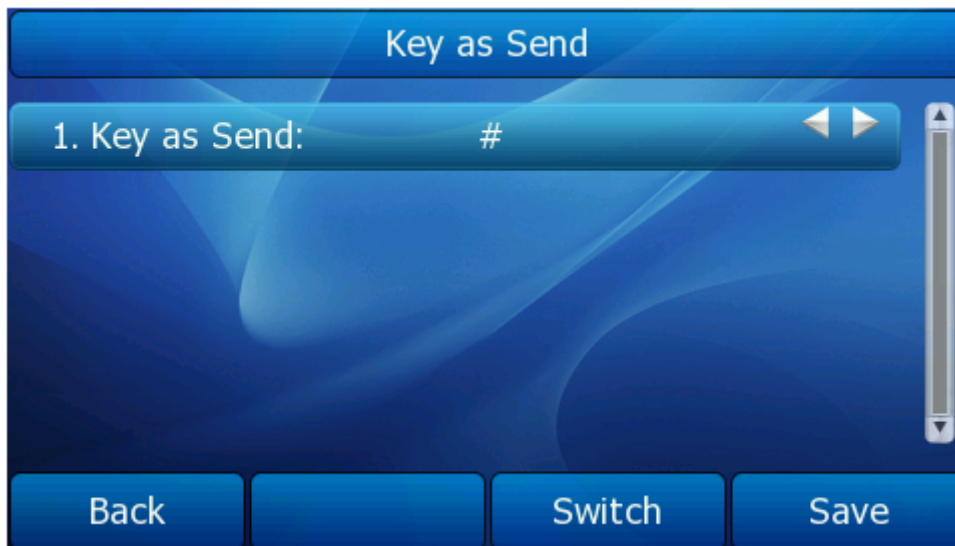

- 2) Press the Switch soft key to choose a button that you want to use as the send key: "#", "\*", or disable this option.
- 3) Press the Save soft key to save the changes.

To set the send key via the Web interface:

- 1) Choose Phone->Features->Key As Send.
- 2) Highlight the specific one in the pull-down menu, then click confirm button to save the change.

<ul style="list-style-type: none"> <li>Auto Provision</li> <li>Configuration</li> <li>Dial Plan</li> <li>Voice</li> <li>Ring</li> <li>Tones</li> <li>SMS</li> <li>Action URL</li> <li>Softkey Layout</li> </ul>	Off Code	<input type="text"/>	?	<p><b>Target</b> The number to which the incoming calls will be forwarded.</p> <p><b>On Code</b> The code that will be sent to PBX when it is switched On.</p> <p><b>Off Code</b> The code that will be sent to PBX when it is switched Off.</p> <p><b>Call Waiting</b> This call feature allows your phone to accept other incoming calls during the conversation.</p> <p><b>Key As Send</b> Select * or # as the send key.</p> <p><b>Hotline Number</b> When you pick up the phone, it will dial out the hotline number automatically.</p> <p><b>Upload Logo</b> The picture must be format of dob, it can be black and white, or 2 gray scale.</p>	
	<b>Busy</b>	<input type="radio"/> On <input checked="" type="radio"/> Off			
	Target	<input type="text"/>	?		
	On Code	<input type="text"/>	?		
	Off Code	<input type="text"/>	?		
	<b>No Answer</b>	<input type="radio"/> On <input checked="" type="radio"/> Off			
	After Ring Time(seconds)	<input type="text" value="10"/>	?		
	Target	<input type="text"/>	?		
	On Code	<input type="text"/>	?		
	Off Code	<input type="text"/>	?		
	<b>General Information:</b>				
	Live Dialpad	<input type="text" value="Disabled"/>	?		
	Inter Digit Time(1~14)(seconds)	<input type="text" value="4"/>	?		
	Call Waiting	<input type="text" value="Enabled"/>	?		
	Call Waiting Tone	<input type="text" value="Enabled"/>	?		
	Auto redial	<input type="text" value="Disabled"/>	?		
	Auto redial interval(1~300s)	<input type="text" value="10"/>	?		
	Auto redial times(1~300)	<input type="text" value="10"/>	?		
	Key As Send	<input type="text" value="#"/>	?		
	Reserve # in User Name	<input type="text" value="Enabled"/>	?		
	Button Sound	<input type="text" value="Enabled"/>	?		
	Send Sound	<input type="text" value="Enabled"/>	?		
	Hotline Number	<input type="text"/>	?		
	Hotline Delay	<input type="text" value="4"/>	?		

## Hot Line

To set the hot line number via the IP phone interface:

- 1) Press Menu->Features->Hot Line to enter the configuration page.

- 2) Enter the hot line number and HotLine Delay time (for example, 10 seconds), then press the Save soft key to save the changes.
- 3) When you pick up the handset or press the speaker button, it will dial out the number automatically if you do not press any keys for 10 seconds.

To set the Hot Line via the Web interface:

- 1) Choose Phone->Features.
- 2) Input the Hotline Number and Hotline Delay, and then click the Confirm button to save the change.

Call Waiting Tone	Enabled	?
Auto redial	Disabled	?
Auto redial interval(1~300s)	10	?
Auto redial times(1~300)	10	?
Key As Send	#	?
Reserve # in User Name	Enabled	?
Button Sound	Enabled	?
Send Sound	Enabled	?
Hotline Number		?
Hotline Delay	4	?
ReDialTone		?
Emergency		?
BusyToneDelay(seconds)	0	?
Ringer Device for Headset	Use Speaker	?
Headset Send Volume(1~53)	29	?
Return code when refuse	486 (Busy here)	?
Return code when DND	480 (Temporarily not av	?
DND On Code		?
DND Off Code		?
Allow Intercom	Enabled	?
Intercom Mute	Disabled	?
Intercom Tone	Enabled	?
Intercom Barge	Enabled	?
Enable Semi-Attend Transfer	Enabled	?
Call Completion	Disabled	?

## Anonymous Call

To set the anonymous call via the IP phone interface:

- 1) Press Menu ->Features->Anonymous Call to enter the configuration page.

### Anonymous Call

1. Line ID:	Line 1	◀ ▶
2. Anonymous Call:	Disable	◀ ▶
3. Call On Code:		
4. Call Off Code:		
5. Rejection:	Disable	◀ ▶

Back      Switch      Save

- 2) By the Switch soft key, you can choose the Line ID.
- 3) Press the navigation keys to enter and choose whether to enable the anonymous call function. This feature allows the subscriber to make a call with the display of their calling identification information blocked.
- 4) If you want to realize this function by server, please choose and enter the Call On Code and Call Off Code. When you choose to enable the anonymous call function on your IP phone, it will send information to the server, and the server will enable/disable the anonymous call function for your IP phone automatically.
- 5) Press the navigation keys to enter and choose whether to enable the anonymous rejection function. The feature allows the subscriber to reject all calls from callers who have blocked the display of their calling identification information (calling number and calling name).
- 6) If you want to realize this function by server, please choose and enter the Reject On Code and Reject Off Code. When you choose to enable the Rejection option on your IP phone, it will send information to the server, and the server will enable/disable the rejection anonymous call function for your IP phone automatically.
- 7) Press the Save soft key to save the changes.

To set the anonymous call via the Web interface:

- 1) Choose Account-> Basic-> Anonymous Call to do the relating changes. Please refer to the instruction above for the parameters' detail.
- 2) Then click the Confirm button to save the changes.

User Name	0599111	?	User account, provided by VoIP service provider.
Password	.....	?	
SIP Server	10.2.1.199	Port 5060 ?	<b>NAT Traversal</b> Defines the STUN server will be active or not.
Enable Outbound Proxy Server	Disabled	?	<b>Proxy Require</b> A special parameter just for Nortel server. If you login to Nortel server, the value should be: com.nortelnetworks.firewall
Outbound Proxy Server		Port 5060 ?	<b>Codecs</b> Choose the codecs you want to use.
Transport	UDP	?	<b>Advanced</b> The Advanced parameters for administrator.
Backup Outbound Proxy Server		Port 5060 ?	
NAT Traversal	Disabled	?	
STUN Server		Port 3478 ?	
Voice Mail		?	
Proxy Require		?	
Anonymous Call	Off	?	
On Code		?	
Off Code		?	
Anonymous Call Rejection	Off	?	
On Code		?	
Off Code		?	
Missed call log	Enabled	?	
Auto Answer	Disabled	?	
XMLIdleScreen Active	Disabled	?	
XmlIdleScreen URL		?	
Ring Type	common	?	
<input type="button" value="Confirm"/> <input type="button" value="Cancel"/>			

## Auto Redial

Auto redial is a telephone feature that redials a busy number in a fixed number of times before giving up.

To set auto redial via phone interface:

- 1) Press Menu->Features->Auto Redial to enter the configuration page.



- 2) By the Switch soft key, you can choose whether to enable the auto redial function.
- 3) Press the navigation keys to choose and set the redial interval. It is measured by second.
- 4) Press the navigation keys to choose and set the redial times.
- 5) Press Save soft key to save the changes.

**Note:**

When you dial a busy number after setting the auto redial function to Enable, the phone will pop up a Auto Redial window to make sure whether you want to redial. If you want, press OK. If you do nothing in this interface for 5 seconds, it will turn to the idle interface automatically.

To set auto redial via the Web interface:

- 1) Choose Phone-> Features-> Auto Redial.
- 2) Choose Enabled or Disabled in the pull-down menu.
- 3) Enter the redial interval and redial times in the corresponding fields.
- 4) Click Confirm button to save the change.

DND	On Code	<input type="text"/>	?
Action URL	Off Code	<input type="text"/>	?
Softkey Layout	<b>General Information:</b>		
	Live Dialpad	Disabled	?
	Inter Digit Time(1~14)(seconds)	4	?
	Call Waiting	Enabled	?
	Call Waiting Tone	Enabled	?
	Auto redial	Disabled	?
	Auto redial interval(1~300s)	10	?
	Auto redial times(1~300)	10	?
	Key As Send	#	?
	Reserve # in User Name	Enabled	?
	Button Sound	Enabled	?
	Send Sound	Enabled	?
	Hotline Number	<input type="text"/>	?
	Hotline Delay	4	?
	ReDialTone	<input type="text"/>	?
	Emergency	<input type="text"/>	?
	BusyToneDelay(seconds)	0	?
	Ringer Device for Headset	Use Speaker	?
	Headset Send Volume(1~53)	29	?
	Return code when refuse	486 (Busy here)	?
	Return code when DND	480 (Temporarily not av)	?
	DND On Code	<input type="text"/>	?

**Key As Send**  
Select \* or # as the send key.

**Hotline Number**  
When you pick up the phone, it will dial out the hotline number automatically.

**Upload Logo**  
The picture must be format of dob, it can be black and white, or 2 gray scale.

## DND Code

You can set DND function by the DND Code via phone interface:

- 1) Go to Menu->Features->DND Code to enter the configuration page.

- 2) Set the DND On Code and the DND Off Code, then press the Save soft key to save the changes.
- 3) When you press the DND soft key, the phone will send a message to the server, and the server will turn on the DND function. Then any calls to the extension will be

rejected by the server automatically. And the incoming call record will not be displayed in the Call History.

Set DND function by the DND Code via web interface:

- 1) Choose Phone-> Features ->DND On Code/ DND Off Code.
- 2) Enter the corresponding contents.
- 3) Click the Confirm to save the changes.

Headset Send Volume(1~53)	<input type="text" value="29"/>	?
Return code when refuse	<input type="text" value="486 (Busy here)"/>	?
Return code when DND	<input type="text" value="480 (Temporarily not av)"/>	?
DND On Code	<input type="text"/>	?
DND Off Code	<input type="text"/>	?
Allow Intercom	<input type="text" value="Enabled"/>	?
Intercom Mute	<input type="text" value="Disabled"/>	?
Intercom Tone	<input type="text" value="Enabled"/>	?
Intercom Barge	<input type="text" value="Enabled"/>	?
Enable Semi-Attend Transfer	<input type="text" value="Enabled"/>	?
Call Completion	<input type="text" value="Disabled"/>	?
Blind Transfer OnHook	<input type="text" value="Enabled"/>	?
Attend Trans OnHook	<input type="text" value="Enabled"/>	?
Transfer on Conference Hang up	<input type="text" value="Disabled"/>	?
Feature Key Synchronisation	<input type="text" value="Disabled"/>	?
Time Out for Dial-now Rule	<input type="text" value="4"/>	?
ACD Auto Available	<input type="text" value="Disabled"/>	?
ACD Auto Available Timer(0~120s)	<input type="text" value="60"/>	?
RFC 2543 Hold	<input type="text" value="Disabled"/>	?
Use Outbound Proxy In Dialog	<input type="text" value="Enabled"/>	?
IsDeal180	<input type="text" value="Enabled"/>	?
SaveCallHistory	<input type="text" value="Enabled"/>	?
DTMFRepetition	<input type="text" value="3"/>	?

## Intercom

Intercom mode is useful in an office environment as a quick access to connect to the operator or the secretary.

To configure Intercom option via phone interface:

- 1) Press Menu->Features->Intercom to enter the configuration page.



- 2) Intercom Allow: To set whether to answer the incoming intercom calls.
- 3) Intercom Mute: To set whether to mute the incoming intercom calls automatically.
- 4) Intercom Tone: To set whether to play ring tones when there is incoming intercom calls to your extension.
- 5) Intercom Barge: To set whether to answer the incoming intercom calls during a conversation. If the option is enabled, when there is incoming intercom calls to your extension, if you are on an intercom conversation, it will refuse the call automatically; or it will put the current call on hold and put the incoming intercom call through.
- 6) Choose and set the different options by navigation keys and the Switch soft key.
- 7) Press the Save soft key to save the changes.

To configure Intercom option via web interface:

- 1) Choose Phone->Features
- 2) Configure Allow Intercom, Intercom Mute, Intercom Tone or Intercom Barge. For more information you can refer to the content above.
- 3) Click the Confirm button to save the changes.



Headset Send Volume(1~53)	<input type="text" value="29"/>	?
Return code when refuse	<input type="text" value="486 (Busy here)"/>	?
Return code when DND	<input type="text" value="480 (Temporarily not av)"/>	?
DND On Code	<input type="text"/>	?
DND Off Code	<input type="text"/>	?
Allow Intercom	<input type="text" value="Enabled"/>	?
Intercom Mute	<input type="text" value="Disabled"/>	?
Intercom Tone	<input type="text" value="Enabled"/>	?
Intercom Barge	<input type="text" value="Enabled"/>	?
Enable Semi-Attend Transfer	<input type="text" value="Enabled"/>	?
Call Completion	<input type="text" value="Disabled"/>	?
Blind Transfer OnHook	<input type="text" value="Enabled"/>	?
Attend Trans OnHook	<input type="text" value="Enabled"/>	?
Transfer on Conference Hang up	<input type="text" value="Disabled"/>	?
Feature Key Synchronisation	<input type="text" value="Disabled"/>	?
Time Out for Dial-now Rule	<input type="text" value="4"/>	?
ACD Auto Available	<input type="text" value="Disabled"/>	?
ACD Auto Available Timer(0~120s)	<input type="text" value="60"/>	?
RFC 2543 Hold	<input type="text" value="Disabled"/>	?
Use Outbound Proxy In Dialog	<input type="text" value="Enabled"/>	?
IsDeal180	<input type="text" value="Enabled"/>	?
SaveCallHistory	<input type="text" value="Enabled"/>	?
DTMFRepetition	<input type="text" value="3"/>	?

## Call Completion

Have encountered such a situation? When you call a contact, but the other side is busy on a call. Do you want the server to inform you immediately when the contact ends the call, in order to establish a conversation with each other in time? Call Completion can help you to solve this problem.

To configure Call Completion via phone interface:

- 1) Press Menu->Features->Call Completion to enter the configuration page.



- 2) By the Switch soft key, choose whether to enable this option.
- 3) Press the Save soft key to save the changes.

## Broadsoft Settings menu

### Broadsoft Dir Settings

Broadsoft phone book is the same as the Remote Phone Book. This feature allows you to download contact list from the server.

For more information about "Remote Phone Book", refer to ["Remote Phone Book"](#)

Configure Broadsoft directory via phone interface:

- 1) Press Menu->Features->Broadsoft Settings Menu->Broadsoft Dir Settings
- 2) Choose Broadsoft Item, enter the Display Name, Server, Port, User Name and Password.
- 3) Press the Save soft key to save the changes.



Configure Broadsoft directory via web interface:

- 1) Choose Contacts->Broadsoft.
- 2) Choose the Broadsoft Item, and then input the Display Name, Server, Port, User Name and Password.
- 3) Click the Confirm button to save the changes.

To check the Broadsoft phone book via Phone interface:

- 1) Press Directory->Broadsoft to enter the Broadsoft Group page.
- 2) Choose a special one, and press the Enter soft key, it will go to the corresponding URL address to download the contact information for you.

**Note:**

1. This IP phone can support 6 broadsoft phone books at most.

## CallLog Settings

This feature allows you to download call history from the server.

Configure Broadsoft Call Log via phone interface:

- 1) Press Menu->Features->Broadsoft Settings Menu->CallLog Settings
- 2) Choose CallLog Item, enter the Display Name, Server, Port, User Name and Password.
- 3) Press the Save soft key to save the changes.

Configure Call Log via web interface:

- 1) Choose Contacts->Call Log.
- 2) Choose the Calllog Item, and then input the DisplayName, Server, Port, User and Password.
- 3) Click the Confirm button to save the changes.

The screenshot shows the Yealink web interface with the 'Contacts' tab selected. The 'Calllog' section is active, displaying a form with the following fields: 'Callog Item' (dropdown menu set to 'Callog1'), 'DisplayName', 'Server', 'Port', 'User', and 'Password'. Each field has a help icon (question mark). Below the form are 'Confirm' and 'Cancel' buttons. On the right, there is a 'NOTE' section with the text 'Contacts-Calllog Note'. The left sidebar contains navigation links for 'Contacts', 'Remote Phone Book', 'Phone Call Info', 'LDAP', 'Broadsoft', and 'Calllog'.

Check Call Log via phone interface:

- 1) Press Menu->History->Network CallLog to enter the CallLog Menu page
- 2) Choose the Call log Item, press Enter soft key to download the call log.

## History Setting

User can set up whether to save Call history Record or not. Enable this function, the phone will save the call history record, if choose disable, the phone will not save call history record.

Configure this function via phone interface:

- 1) Press Menu->Features->History Setting.
- 2) By the Switch soft key, choose whether to enable this option.
- 3) Press the Save soft key to save the changes.



Configure this function via web interface:

- 1) Choose Phone->Features-> SaveCallHistory.
- 2) In the pull-down menu, choose enable or disable this function.
- 3) Click the Confirm button to save the changes.

Return code when refuse	486 (Busy here)	?
Return code when DND	480 (Temporarily not av)	?
DND On Code		?
DND Off Code		?
Allow Intercom	Enabled	?
Intercom Mute	Disabled	?
Intercom Tone	Enabled	?
Intercom Barge	Enabled	?
Enable Semi-Attend Transfer	Enabled	?
Call Completion	Disabled	?
Blind Transfer OnHook	Enabled	?
Attend Trans OnHook	Enabled	?
Transfer on Conference Hang up	Disabled	?
Feature Key Synchronisation	Disabled	?
Time Out for Dial-now Rule	4	?
ACD Auto Available	Disabled	?
ACD Auto Available Timer(0~120s)	60	?
RFC 2543 Hold	Disabled	?
Use Outbound Proxy In Dialog	Enabled	?
IsDeal180	Enabled	?
SaveCallHistory	Enabled	?
DTMFRepetition	3	?

## Directory

### Local Directory

To add a Group via Phone interface:

- 1) Press Directory->Local Directory to enter into the contacts page.
- 2) Press AddGroup soft key to enter into the Add Group page.
- 3) Enter the Group Name and choose the Ring.
- 4) Press the Save soft key to save.

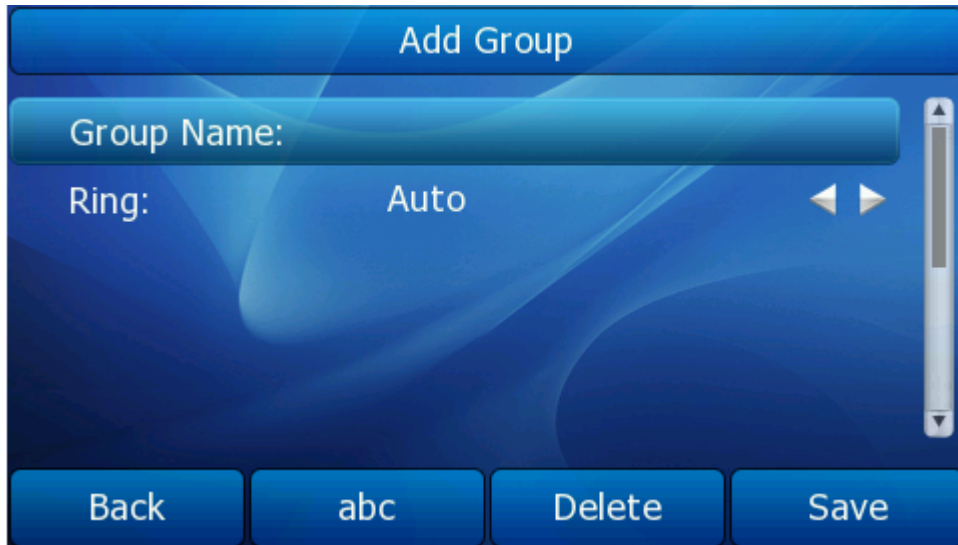

All the contacts will show on the Contacts group. For example: if you add a contact in AAA group. Add another contact in BBB group. And then you can check the records in each group. Also you can check all the records in Contacts group.

To delete a Group via Phone interface:

- 1) Press Directory->Local Directory to enter into the contacts page.
- 2) Choose a group, Press Option->Delete/Delete All Group soft key to delete this or all group.
- 3) It will pop up a warning window asking whether confirm to delete the group.
- 4) Press OK soft key to confirm the operation, or press the Cancel soft key to return to the directory.

Note:

User cannot delete the Contacts group. Contacts is default system group, it can't be deleted.

To add a contact via Phone interface:

- 1) Press Directory->Local Directory
- 2) Choose a group, and press the Enter soft key.
- 3) Press Add soft key, enter Name, Office, Mobile, Other phone number. Use the abc soft key to choose an input method like Numeric, Upper/Lower Case Alphanumeric.
- 4) If you want to assign a contact to a specific account, you can use navigation keys to select desired account.
- 5) Choose and set a special ring tone for the contact.
- 6) Use the navigation keys to select the group which you want to assign.
- 7) Choose photo, and then press Enter soft key to enter into the edit page. Use the navigation keys to select a photo for this contact. Press OK soft key to confirm and return to the previous screen.
- 8) Press Save soft key to add the record to contacts.



9) Press Save soft key to add the record to contacts or Back soft key to cancel.

To edit a contact via Phone interface:

- 1) Press Directory->Local Directory
- 2) Choose a group, and press the Enter soft key.
- 3) Use the navigation key to highlight the one you want to edit, press Option->Detail, and enter into the edit page.
- 4) And then make the changes, press Save soft key to save the changes, or press Back soft key to return to the directory.



To delete a contact via Phone interface:

- 1) Press Directory->Local Directory
- 2) Choose a group, and press the Enter soft key.
- 3) Use the navigation key to highlight the one you want to delete, press Option soft key, and scroll to Delete, press OK soft key.

- 4) It will pop up a warning window asking whether confirm to delete the contact.
- 5) Press OK soft key to confirm the operation, or press the Cancel soft key to return to the directory.

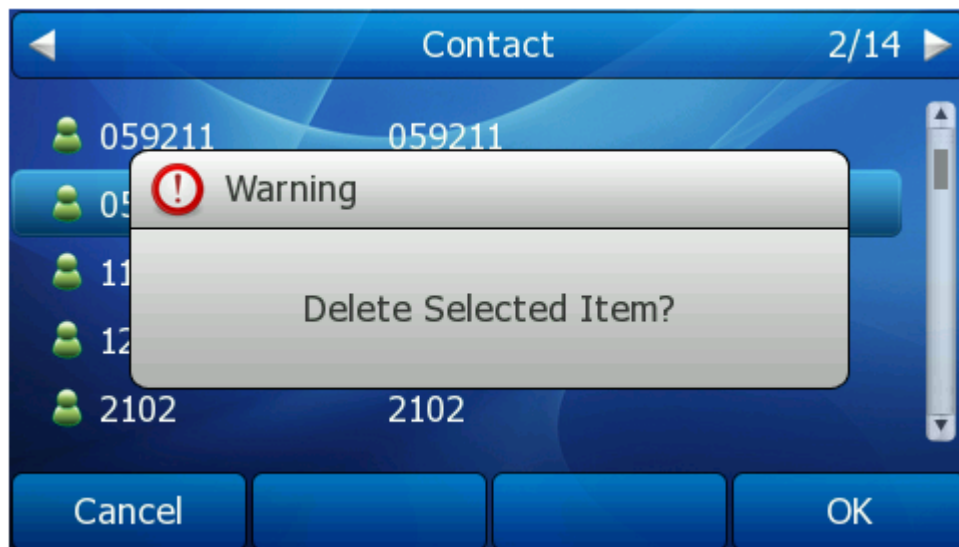

To search a contact via Phone interface:

- 1) Press Directory->Local Directory->Search to enter into the search page. Or choose a group and press the Enter soft key, then press the number keypad to enter into the search page directly.
- 2) It will turn to the search interface, and then you can enter the query condition, press the OK soft key.
- 3) Then the phone will show the record which qualified.

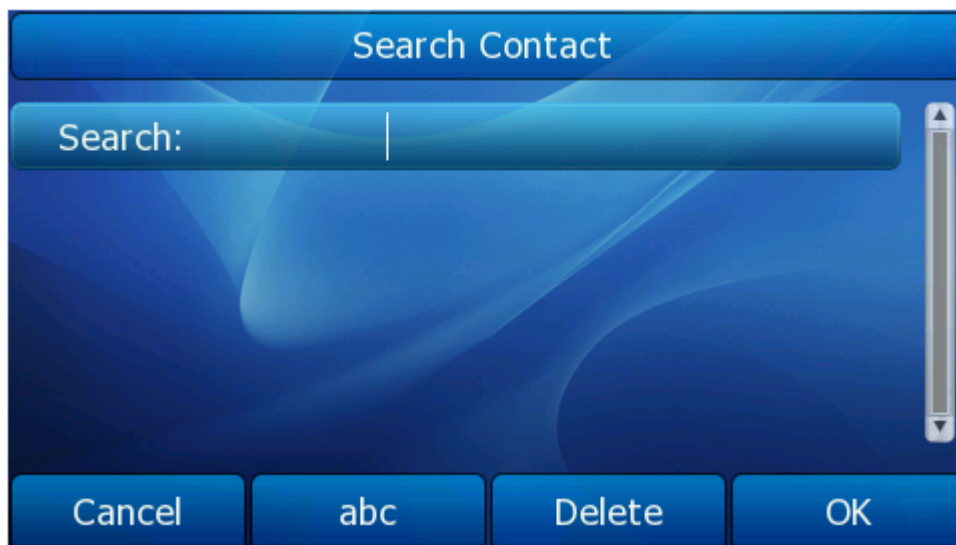

To move a contact to the Blacklist via Phone interface:

- 1) Press Directory->Local Directory
- 2) Choose a group, and press the Enter soft key.

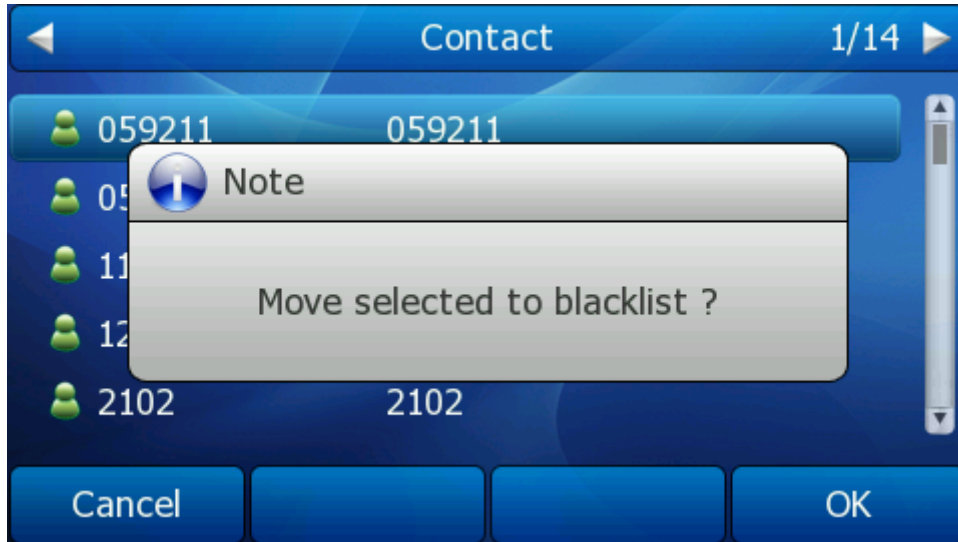

- 3) Use the navigation key to highlight the one you want to move, press Option soft key, and scroll to Move to Blacklist, press OK soft key.
- 4) It will pop up a note window asking whether confirm to move the contact.
- 5) Press OK soft key to confirm the operation, or press the Cancel soft key to return to the directory.

**Note:**

If a contact is moved to the blacklist, then the call from this contact cannot get through.

To move a contact in History to Contacts via Phone interface:

- 1) Press History soft key to enter the local call history list.
- 2) Use the navigation keys to highlight a record, and then press the Option soft key to pop up the field, highlight Add to Contacts option, then press the OK soft key to enter the edit interface.
- 3) Press the abc soft key to switch the input method.
- 4) After the edition, press the Save soft key to save the change. Then you can go to Contacts interface to check the record.



To add/delete/edit/move the contacts via the Web interface:

- 1) Choose Contacts->Contacts->Contacts. Please refer to the instruction above for the parameters' detail.
- 2) In this page, user can add/delete/edit the contacts, also can upload/delete the contact photo.
- 3) When you finish the corresponding operation, you must click the Save button to save the changes.
- 4) Also can export/import contact through this page. For more information, you can refer to "[Import/Export Contact list](#)".

**Yealink** Log Off

Status Account Network DSS Key Phone **Contacts** Security

Contacts **BlackList** Hangup

Index	Display Name	Office Num	Mobile Num	Other Num	Line
					All

Save Del Move To Black List

**Contacts**

Name

Office Num

Mobile Number

Other Num

Account

Ring

Group

Photo



**NOTE**

**Add Contact/Blacklist**  
Fill out the contact information. User shouldn't leave contact name blank.

**Delete Contact/Blacklist**  
Select the contact you want to delete in the grid, and then press the button Delete to confirm.

**Move to Contact/blacklist**  
Choose the contacts you want to move in the grid, and press the button move to Contact/Blacklist to move it.

**Import**  
Browse the file in XML format.

**Export**  
Click Export button and create a file with whose name you prefer to export.

User also can upload the contact photo via web interface:

- 1) Choose Contacts->Contacts->Contacts, click the record which you want to edit.
- 2) And then the record will turn orange.
- 3) And then under the Contacts edit region. Click the Browser button, and then choose a photo from your local computer.
- 4) And then also can click the Delete Photo button to delete the photo.

Yealink Log Off

Status Account Network DSS Key Phone **Contacts** Security

Contacts **BlackList** Hangup

5	2102	<a href="#">2102</a>		Auto		<input type="checkbox"/>
6	2341	<a href="#">2341</a>		Auto		<input type="checkbox"/>
7	66	<a href="#">66</a>		Auto	ccc	<input type="checkbox"/>
8	ad	<a href="#">444</a>		Auto	eee	<input type="checkbox"/>
9	adg	<a href="#">059288</a>		Auto	bbb	<input type="checkbox"/>
10	jd	<a href="#">6666</a>		Auto	eee	<input type="checkbox"/>
11	mtw	<a href="#">059299</a>		Auto	bbb	<input type="checkbox"/>
12	old	<a href="#">3205</a>		Auto		<input type="checkbox"/>
13	tjm	<a href="#">059275</a>		Auto	eee	<input type="checkbox"/>
14	vivi	<a href="#">0599852</a>	<a href="#">0599852</a>	Auto		<input checked="" type="checkbox"/>
15	xzh	<a href="#">059233</a>		Auto		<input type="checkbox"/>

Save Del Move To Black List

**Contacts**

Name:   
 Office Num:   
 Mobile Number:   
 Other Num:   
 Account:   
 Ring:   
 Group:   
 Photo:

  
Delete Photo

浏览...  
Upload Photo

**NOTE**

**Add Contact/Blacklist**  
Fill out the contact information. User shouldn't leave contact name blank.

**Delete Contact/Blacklist**  
Select the contact you want to delete in the grid, and then press the button Delete to confirm.

**Move to Contact/blacklist**  
Choose the contacts you want to move in the grid, and press the button move to Contact/Blacklist to move it.

**Import**  
Browse the file in XML format.

**Export**  
Click Export button and create a file with whose name you prefer to export.

**Note:**

1. The picture file only supports png, jpg, bmp format. The maximum resolution of the upload picture is 96\*96 pixels.
2. User only can delete the picture which is uploaded.
3. A contact can only upload a custom photo. And user can't rename the photo name, the default name is default. If multiple contacts want to use the same photo that can only select contact photo to upload again.

When there is a coming call from the contact, the phone idle interface will show the contact photo.

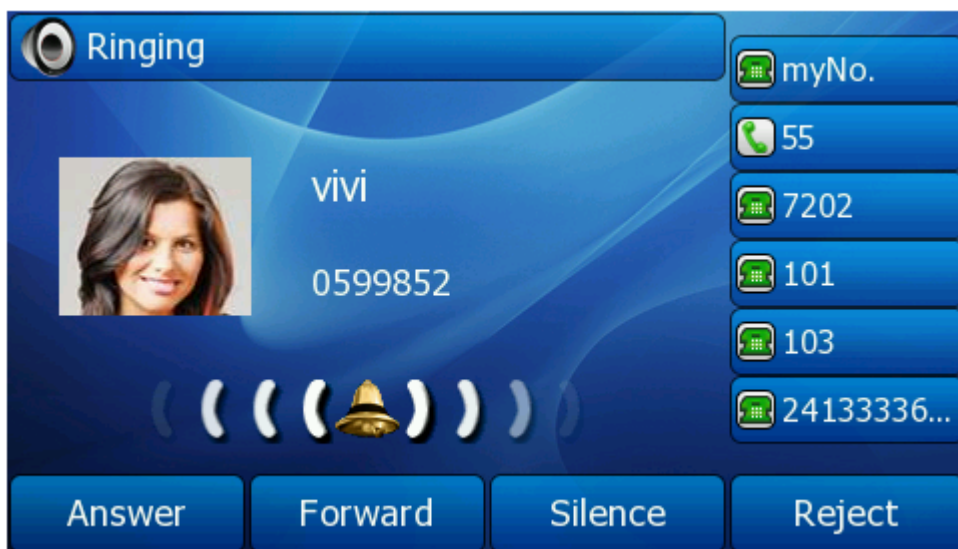

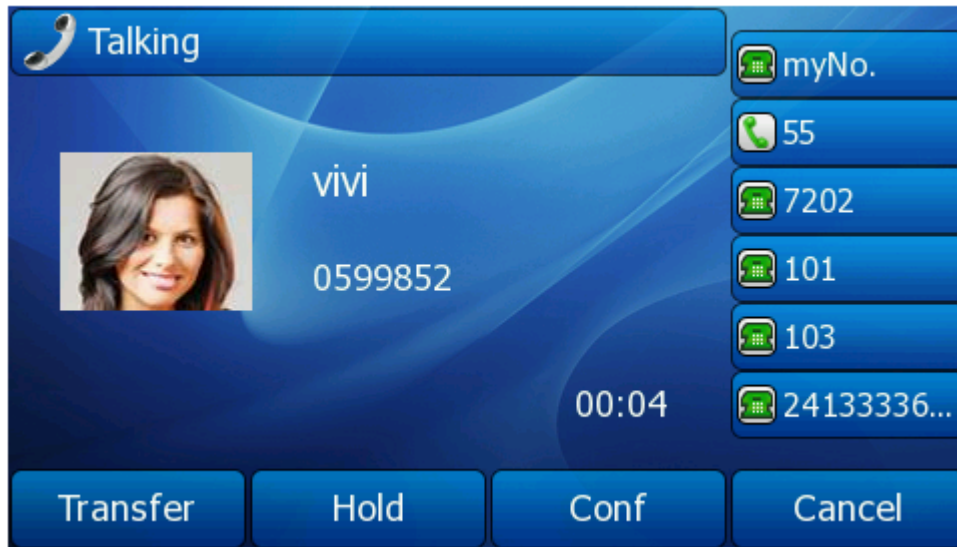

### *Import/Export Contact list*

Import/Export Contact List via Web interface:

- 1) Choose Contacts-> Contacts-> Contacts.
- 2) In the Select import file field, browse the specific contact list file in .XML format or .csv format, and then click Import button. The imported contact lists will be shown in the directory.
- 3) Click the Export button to export the contact list.

**Note:**

Import/Export Contact List can only be set via Web interface.

## **Blacklist**

If you add a contact to blacklist, then the call from this contact cannot get through. The configuration steps are similar as when you configure Local Directory. Please refer to the section of "[Local Directory](#)".

## **Remote Phonebook**

The IP phone has directory itself, but in the enterprise applications where there are a need for a common phone book. For the maintenance and the update of it, the common phone book is usually carried out on the server or IPPBX to maintain up-to-date public phone book, terminal users need to have remote phone book function. When the users browse the remote phone book, the terminal will check and download the latest information released on the server in time, and display on the terminal for the user.

To set the Remote Phonebook via Web interface:

- 1) Choose Contacts->Remote Phone Book.

- 2) Input the Phone book URL and the phone book name, and then click the Confirm button to save the change.

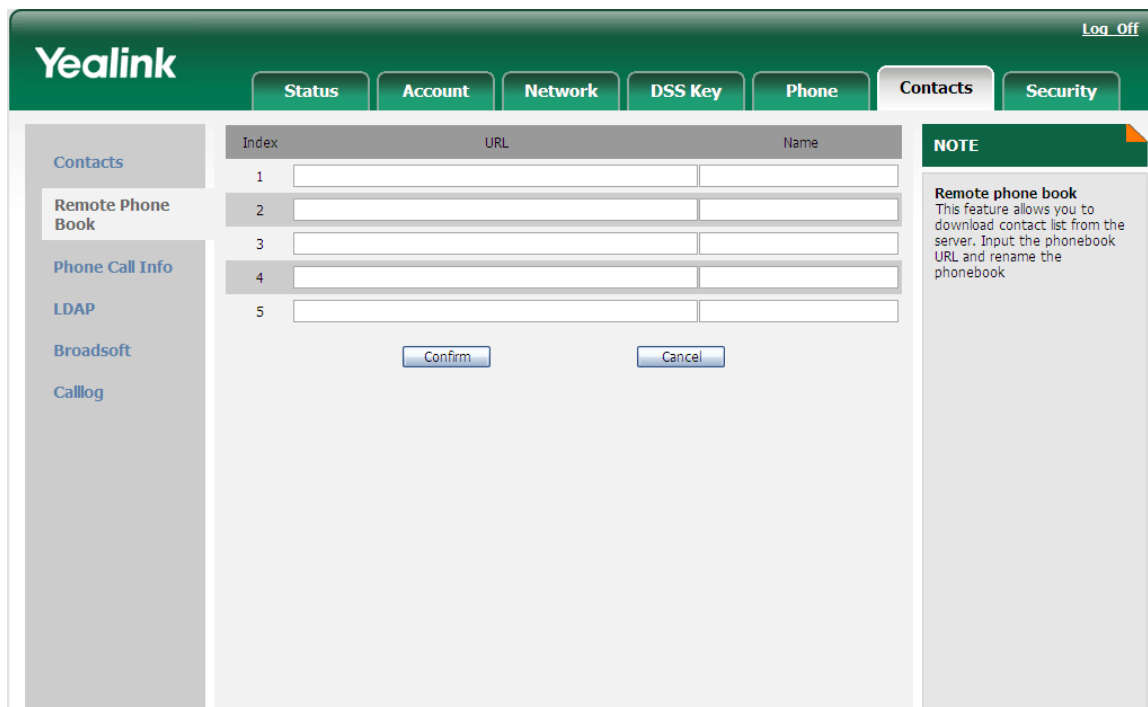

The screenshot shows the Yealink web interface with the 'Contacts' tab selected. The 'Remote Phone Book' section is active, displaying a table with five rows for configuration. Each row has an 'Index' column, a 'URL' input field, and a 'Name' input field. Below the table are 'Confirm' and 'Cancel' buttons. A 'NOTE' box on the right explains the feature: 'Remote phone book. This feature allows you to download contact list from the server. Input the phonebook URL and rename the phonebook.'

Index	URL	Name
1	<input type="text"/>	<input type="text"/>
2	<input type="text"/>	<input type="text"/>
3	<input type="text"/>	<input type="text"/>
4	<input type="text"/>	<input type="text"/>
5	<input type="text"/>	<input type="text"/>

NOTE  
Remote phone book  
This feature allows you to download contact list from the server. Input the phonebook URL and rename the phonebook

To check the Remote Phone Book via Phone interface:

- 3) Press Directory->Remote Phonebook to enter the Remote Group page.
- 4) Choose a specific one, and press the Enter soft key, it will go to the corresponding URL address to download the contact information for you.

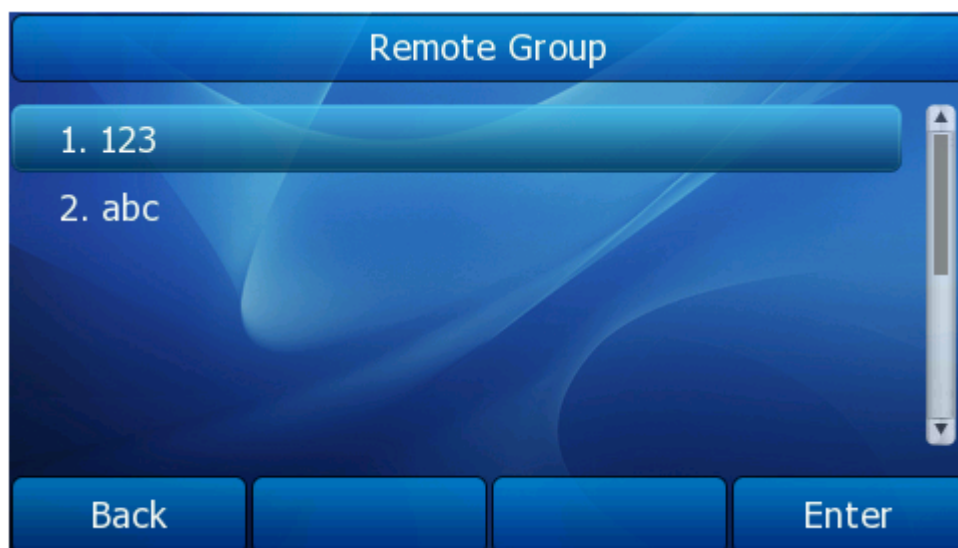

**Note:**

1. This IP phone can support 5 remote phone books at most.
2. Every contact in the remote phone book can set several phone numbers.

## **Broadsoft**

Broadsoft phone book is the same as the Remote Phone Book. This feature allows you to download contact list from the server.

About how to configure this feature, you can refer to "[Broadsoft Dir Settings](#)".

## **LDAP**

LDAP can support these functions:

1. Search the contact: Press the DSS key which is set up as LDAP, input a number or letter in the new interface, the phone will search the contact in LDAP server which following the Certain rules, and show it in the LCD, user can choose the contact to call out.
2. Search the incoming call: the phone will search the local directory when there is a coming call. If they can't find the contact in the local directory, it will search them through LDAP server, and show the contact name in the LCD. The LDAP Lookup For Incoming Call option can be configured to enable or disable this function via web interface.
3. The function of Dial-up directory: under the dial interface, each time you press a key there are inquiring for a number. It will show on the LCD and let the user to choose. The LDAP Lookup For PreDial/Dial option can be configured to enable or disable this function via web interface.

To set the LDAP via the Web interface:

- 1) Choose Contacts->LDAP.
- 2) Configure the corresponding options.
- 3) Click Confirm to save the change.

**Note:**

1. About the parameters, you must consult your system administrator

## History

User can enter into the call log page to check the record. It includes local history and network call log.

## Local History

Check the local history via phone interface:

- 1) Press Menu->History->Local History to enter into the call log page.
- 2) User Left/Right navigation keys to switch the type: All Calls, Dialed Calls, Received Calls, Missed Calls and Forwarded Calls.
- 3) User Up/Down navigation keys to choose a record, you also can press Option soft key to check the details.





## Network CallLog

This feature allows you to download call history from the server. About how to configure this feature, you can refer to "[CallLog Settings](#)".

## Messages

### Voicemail

The phone supports SMS (Short Messaging Service) and Voicemail, if you want to use them, please make sure that your VoIP telephony system supports this functionalities and your accounts' message has been enabled.

Your voice mailbox messages, which are usually stored on a media server of your local or hosted VoIP telephony system, can be accessed from your phone.

New voice messages can be indicated both acoustically and visually as described below:

- The idle screen will indicate the new voice messages coming.
- The MESSAGE button will be lighted.

To configure the Voicemail code via Phone interface:

- 1) Press Menu->Messages->Voice Mail->Set Voice Mail.



- 2) Use the navigation keys to highlight the line for which you want to set, enter the code which the phone uses to connect to your system. Press 123 soft key to choose the proper input method.
- 3) Press Save soft key to save the change, or Back to return to the previous menu.

**Note:**

Please contact your system administrator for the connecting code. Different systems have different codes.

To some server you have to enable Subscribe for MWI via web interface firstly so that the Phone Interface could show the amount of Voice mails.

- 1) Choose Account->Advanced-> Subscribe for MWI.
- 2) Choose enable in the pull-down menu.

Use Session Timer	Disabled	?
Session Timer(seconds)		?
Refresher	Uac	?
Use user=phone	Disabled	?
Voice Encryption(SRTP)	Disabled	?
ptime(ms)	20	?
BLF List URI		?
BLF List Code		?
Shared Line	Disabled	?
Dialog-Info Call Pickup	Disabled	?
BLA Number		?
BLA Subscription Period BSP_Scope	300	?
SIP Send MAC	Disabled	?
SIP Send Line	Disabled	?
SIP Registration Retry Timer (Scope:0~1800)(seconds)	30	?
Enable Signal Encode	Disabled	?
Signal Encode Key		?
Conference Type	Local	?
Conference URI		?
ACD Subscription Period(120~3600)	3600	?
SubscribeMWIToVM	Disabled	?
SIPServerType	Default	?

To view the voicemail via the Phone interface:

- 1) Press Menu->Messages->Voice Mail->View Voice Mail.



- 2) You can view the amount of the voice mail that includes new or old voice mail.
- 3) Choose the account and then press the Connect soft key, then you are able to listen to your new and old messages.

**Note:**

Before listening to the voicemail, please make sure that the connecting code has been set on the phone.

## SMS

To view the SMS via Phone interface:

- 1) Press Menu->Messages->Text Message to enter the text message page.
- 2) Use the Up/Down navigation keys to highlight the options. You can read the message in the Inbox/ Sentbox/ Outbox/ Draftbox.

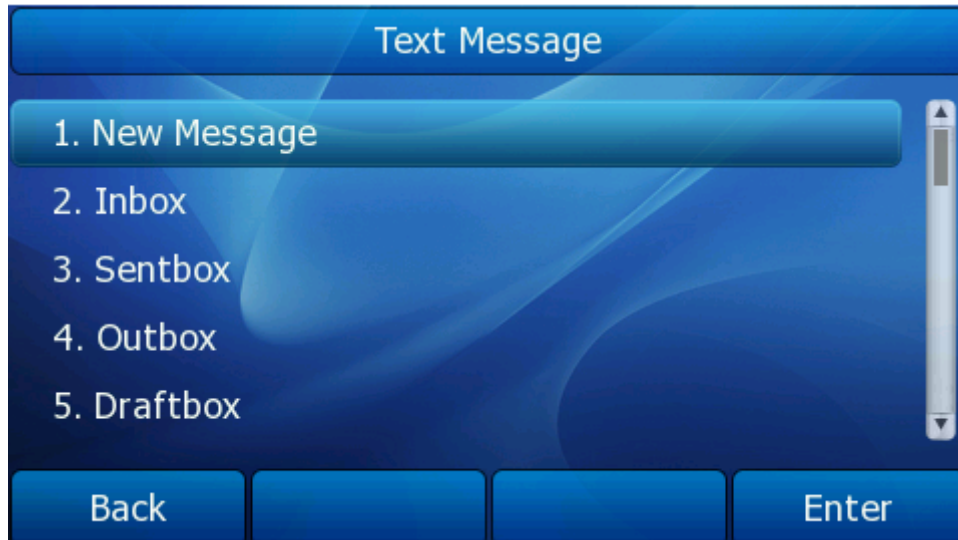

- 3) Press enter soft key, Use the Up/Down navigation keys to choose a message,
- 4) Press View soft key to read the message.

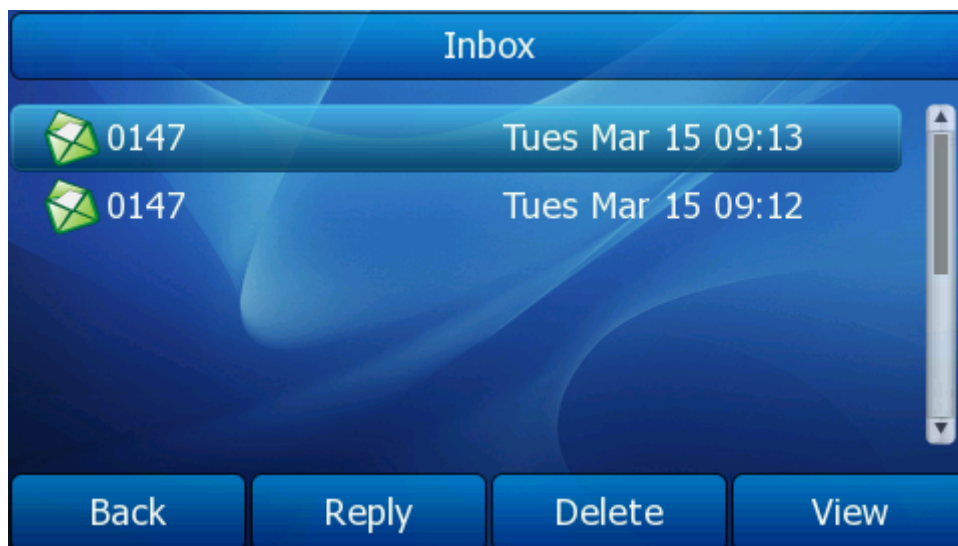

To reply the SMS via Phone interface:

- 1) After view the message, press Reply soft key, enter the contents, use the abc soft key to change the Input Method.



- 2) Press Send soft key, you are required to choose an account which is used to send out the message and the number you want to send to.
- 3) Press Send soft key to send out the message, or Back soft key to return to the previous menu.

To edit a new message via the Phone interface:

- 1) Press Menu->Messages->Text Message->New Message to enter.
- 2) Edit the new message, use the abc soft key to change the input method.
- 3) Press Send soft key, you are required to choose an account which is used to send out the message and the number you want to send to.
- 4) Press Send soft key to send out the message, or Back soft key to return to the previous menu.

To delete the message via the phone interface:

- 1) After view the specific message, user can delete the message.
- 2) Choose a message which you want to delete, press Delete soft key.
- 3) Choose delete a message or delete all message, press OK soft key.
- 4) You are prompted to confirm the delete operation, press Yes soft key to delete the message, or No soft key to return to previous menu.

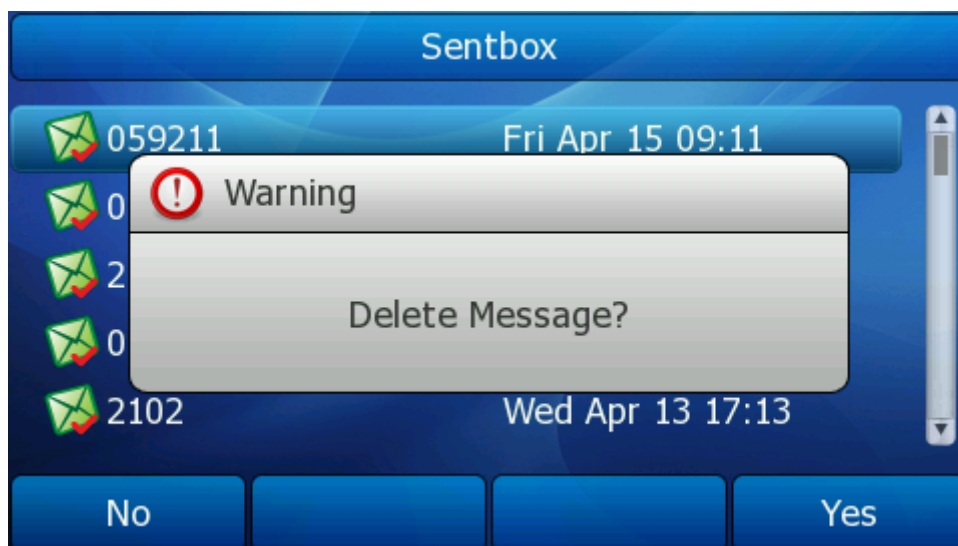
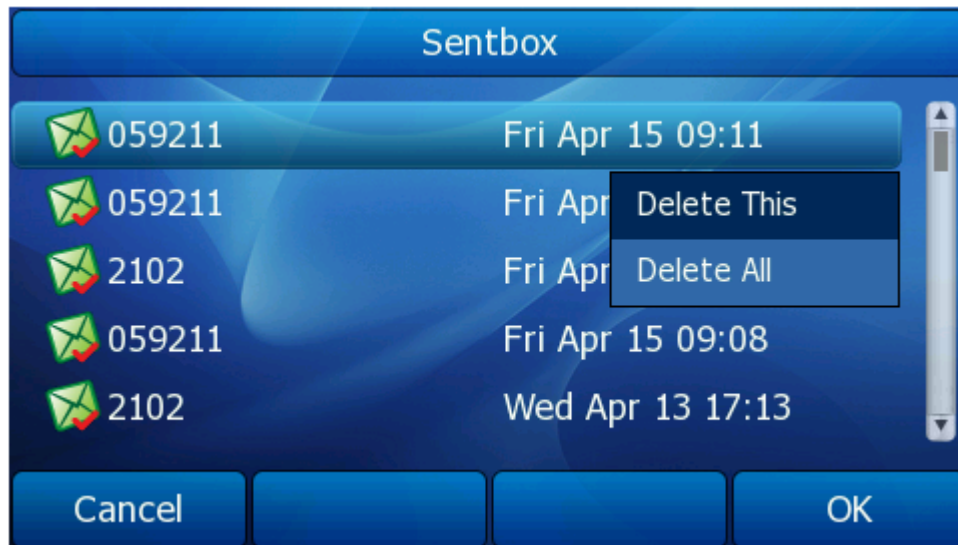

To edit the message via Web interface:

- 1) Choose Phone->SMS.
- 2) You are required to choose an account which is used to send out the message and the number you want to send to.
- 3) Enter the Message content in the Message field.
- 4) Press Confirm button to send out the message, or Cancel button to cancel the operation.

The screenshot shows the Yealink web management interface. At the top, there is a green header with the 'Yealink' logo on the left and a 'Log Off' link on the right. Below the header is a navigation bar with several tabs: 'Status', 'Account', 'Network', 'DSS Key', 'Phone' (which is currently selected), 'Contacts', and 'Security'. On the left side, there is a vertical sidebar menu with the following items: 'Preference', 'Features', 'Upgrade', 'Auto Provision', 'Configuration', 'Dial Plan', 'Voice', 'Ring', 'Tones', 'SMS' (which is highlighted), 'Action URL', and 'Softkey Layout'. The main content area is divided into three sections. The top section is for 'Account' configuration, featuring a dropdown menu with the value '0599111@10.2.1.199'. Below this is a 'Number' field, which is currently empty. The middle section is for 'Message' configuration, featuring a large, empty text area. At the bottom of this section are two buttons: 'Send' and 'Cancel'. The right side of the main content area contains a 'NOTE' box with a green header and an orange corner icon. The note text reads: 'SMS Number: Input the phone number which you are going to send message to.'

## Setting

### Basic Settings

#### Language

The default Phone interface language is **English**. The Web interface language will depend on your computer Operation System. It will automatically match the language with your computer and browser.

It supports Simplified Chinese, Traditional Chinese, French, German, Italian, Portuguese, Spanish, etc. user can change the language for the phone interface and the web interface independently from each other.

To change the phone interface language via Phone interface:

- 1) Press Menu->Setting->Basic Settings->Language.
- 2) Scroll through the list of available languages.
- 3) Press the Save soft key when the desired language is highlighted. The language appears on the graphic display will be changed to the one you chose.



- 4) Press Save soft key to save the changes.

**Note:**

All languages may not be available for selection. The available languages depend on the language packs currently loaded to the IP phone. Please contact with your system administrator for more information about loading language packs.

To change the web page language via Web interface:

- 1) Choose Phone->Preference->WEB Language.
- 2) In the drop-down list, select the displayed language for web page.



3) Click the confirm button to save the changes.

The screenshot shows the Yealink web interface with the 'Phone' tab selected. The 'Time & Date' section is expanded, showing various configuration options. A 'NOTE' box on the right provides additional information about the Time Zone and NTP Server settings.

Setting	Value
WEB Language	English
DHCP Time	Disabled
Time Zone	+8 China(Beijing)
Primary NTP Server	cn.pool.ntp.org
Secondary NTP Server	cn.pool.ntp.org
Update Interval(seconds)	1000
Daylight Saving Time	Automatic
Fixed Type	<input checked="" type="radio"/> By Date <input type="radio"/> By Week
Start Month	January
Start Date	1
Start Hour of Day	0
Start Day of Week	Sunday
Start Day of Week Last in Month	First In Month
Stop Month	January
Stop Date	31
Stop Hour of Day	23
Stop Day of Week	Sunday
Stop Day of Week Last in Month	First In Month
Offset(minutes)	
Manual Time	Disabled

**NOTE**

**Time Zone:**  
Choose the time zone you are in.

**NTP Server:**  
The server which is used to synchronize the clock of the phone.

## Time & Date

The time and date appears on the idle screen of the IP phone. If the phone cannot obtain a time and date from the call server, please contact your system administrator. If the time or date is incorrect, you can set the time manually or via the SNTP server which is used to synchronize the time.

To change the Time and Date via the Phone interface:

- 1) Press Menu-> Setting->Basic Settings ->Time & Date.
- 2) If SNTP Settings is chosen, the phone will automatically get the time from the specific NTP Server. Use the navigation keys to highlight the specific option and the relating changes. User can set the Time Zone, NTP Server1/NTP Server2, and Daylight Saving respectively.



- 3) If Manual Setting is chosen, the time can be set manually. Use the navigation keys to highlight the option and enter the specific date and time.



- 4) Press Save soft key, the time appears on the idle screen will be changed.

To change the Daylight Saving Time Settings via the Web interface:

- 1) Choose Phone->Preference->Daylight Saving Time to do the relating changes.
- 2) Choose Enable option, and then you can set the Daylight Saving Time. You can set daylight time by date or by week, and then choose or enter the corresponding contents
- 3) Choose Automatic. There is a table named as AutoDST.xml has been saved in the configuration file, if the table includes daylight saving time of your time zone, it will show the Fixed Type: By Date or By Week. And the daylight saving time is unchangeable, unless to update the AutoDST.xml via auto provision.

**Yealink** Log Off

**Status** **Account** **Network** **DSS Key** **Phone** **Contacts** **Security**

**Preference**

**Features**

**Upgrade**

**Auto Provision**

**Configuration**

**Dial Plan**

**Voice**

**Ring**

**Tones**

**SMS**

**Action URL**

**Softkey Layout**

WEB Language: English ?

DHCP Time: Disabled

Time Zone: +8 China(Beijing) ?

Primary NTP Server: cn.pool.ntp.org ?

Secondary NTP Server: cn.pool.ntp.org ?

Update Interval(seconds): 1000 ?

Daylight Saving Time: Automatic ?

Fixed Type:  By Date  By Week

Start Month: January

Start Date: 1

Start Hour of Day: 0

Start Day of Week: Sunday

Start Day of Week Last in Month: First In Month

Stop Month: January

Stop Date: 31

Stop Hour of Day: 23

Stop Day of Week: Sunday

Stop Day of Week Last in Month: First In Month

Offset(minutes):

Manual Time: Disabled ?

**NOTE**

**Time Zone:**  
Choose the time zone you are in.

**NTP Server:**  
The server which is used to synchronize the clock of the phone.

## Time & Date Format

To set the time & date format via phone interface:

- 1) Press Menu-> Setting->Basic Settings ->Time & Date Format.



- 2) Use the Switch soft key to choose a preferred time format: 12 Hour or 24 Hour.
- 3) Use the Navigation keys to choose a preferred date format, the IP phone can support 7 kind of date display format.
- 4) Press the Save soft key to save the changes.

## DHCP Time

User can set the phone to get time automatic from DHCP server.

To set this function via phone interface:

- 1) Press Menu-> Setting->Basic Settings ->DHCP Time
- 2) By the Switch soft key, choose whether to enable this option.
- 3) Press the Save soft key to save the changes.



**NOTE:**

- 1) User can set the time information via web interface, Choose Phone->Preference, choose the Corresponding options to configure.
- 2) For more information about the function, user can refer to the contents above.

## Ring Tone

You can adjust the type and volume of the ring tone.

To adjust the Ring Tone Type via Phone interface:

- 1) Press Menu-> Setting->Basic Settings-> Ring Tone.
- 2) Use the navigation keys to highlight the specific one.
- 3) Press Save soft key to save the change.



To change the Ring Tone Type via Web interface:

- 1) Choose Phone->Preference->Ring Type.
- 2) Highlight the specific one in the pull-down menu.
- 3) Click confirm button to save the changes.
- 4) You can also delete the specific one by clicking the Del button.

Offset(minutes)	<input type="text"/>
Manual Time	Disabled <input data-bbox="997 1079 1013 1102" type="button" value="?"/>
Data	Year <input type="text" value="2011"/> Month <input type="text" value="04"/> Day <input type="text" value="20"/>
Time	Hour <input type="text" value="17"/> Minute <input type="text" value="52"/> Second <input type="text" value="06"/>
Time Format	24 Hour <input data-bbox="997 1182 1013 1205" type="button" value="?"/>
Date Format	WWW MMM DD <input data-bbox="997 1218 1013 1240" type="button" value="?"/>
Active Backlight Level	6 <input data-bbox="997 1254 1013 1276" type="button" value="?"/>
Inactive BackLight Level	Enabled <input data-bbox="997 1290 1013 1312" type="button" value="?"/>
Backlight Time(seconds)	1min <input data-bbox="997 1326 1013 1348" type="button" value="?"/>
PhoneTheme	Blue <input data-bbox="997 1361 1013 1384" type="button" value="?"/>
Keyboard Lock	Disabled <input data-bbox="997 1397 1013 1420" type="button" value="?"/>
WatchDog	Enabled <input data-bbox="997 1433 1013 1456" type="button" value="?"/>
Ring Type	Ring1.wav <input type="button" value="Del"/> <input data-bbox="1093 1456 1109 1478" type="button" value="?"/>
Upload Ringtone	<input type="text"/> <input type="button" value="浏览..."/> <input type="button" value="Upload"/> <input type="button" value="Cancel"/>
WallPaper	pictures (06).png <input type="button" value="Del"/> <input data-bbox="1093 1556 1109 1579" type="button" value="?"/>
Load BgPicture	<input type="text"/> <input type="button" value="浏览..."/> <input type="button" value="Upload"/> <input type="button" value="Cancel"/>
ScreensaverTime(seconds)	1min <input data-bbox="997 1657 1013 1680" type="button" value="?"/>
ScreenSaver	01.png <input type="button" value="Del"/> <input data-bbox="1093 1691 1109 1713" type="button" value="?"/>
Load Screensaver	<input type="text"/> <input type="button" value="浏览..."/> <input type="button" value="Upload"/> <input type="button" value="Cancel"/>
<input type="button" value="Confirm"/> <input type="button" value="Cancel"/>	

**Note:**

The ring tone file of system cannot be deleted.

To upload the new Ring Tone via Web interface:

- 1) Choose Phone->Preference->Upload Ringtone.
- 2) Click Browse button to choose the specific ring tone file.
- 3) Click Upload button to upload the file.

**Note:**

The ring tone file format must be 16bits WAV format, 8K sample rate. Blank or other special characters cannot be included in the file name.

To specify ring tones for a specific account via Web interface:

Choose Account->Basic->Ring Type option, and highlight the preferred one for the chosen account in the pull-down menu, then click confirm button to save the changes.

User Name	0599111	?	<b>User Name</b> User account, provided by VoIP service provider.
Password	.....	?	
SIP Server	10.2.1.199	Port: 5060 ?	<b>NAT Traversal</b> Defines the STUN server will be active or not.
Enable Outbound Proxy Server	Disabled	?	<b>Proxy Require</b> A special parameter just for Nortel server. If you login to Nortel server, the value should be: com.nortelnetworks.firewall
Outbound Proxy Server		Port: 5060 ?	<b>Codecs</b> Choose the codecs you want to use.
Transport	UDP	?	<b>Advanced</b> The Advanced parameters for administrator.
Backup Outbound Proxy Server		Port: 5060 ?	
NAT Traversal	Disabled	?	
STUN Server		Port: 3478 ?	
Voice Mail		?	
Proxy Require		?	
Anonymous Call	Off	?	
On Code		?	
Off Code		?	
Anonymous Call Rejection	Off	?	
On Code		?	
Off Code		?	
Missed call log	Enabled	?	
Auto Answer	Disabled	?	
XMLIdleScreen Active	Disabled	?	
XmlIdleScreen URL		?	
Ring Type	common	?	
<input type="button" value="Confirm"/> <input type="button" value="Cancel"/>			

You can adjust the volume of handset/speaker/headset/Ring.

On the corresponding interface, press the Volume adjusting bar to adjust the corresponding volume.

For example:

- 1) On the idle interface, press the Volume adjusting bar to adjust the ring tone volume.
- 2) On the Handset/Speaker/Headset call interface, press the Volume adjusting bar to adjust the Handset/Speaker/Headset call volume.

## Advanced Settings

User can enter the advanced settings page to configure some advance features. Enter

into the advanced settings page must input administrator password at first.



## Account

Please refer to the previous part "[Configuration and Registration](#)" for the basic Account setting information.

## Network

### *WAN Port*

Please refer to the previous part "[Configuration and Registration](#)" for the basic WAN setting information.

### *PC Port*

The following table lists the instructions of the field about the Network PC Port Setting.

Field Name	Description
<i>As Bridge</i>	If you select the Bridge mode, then the two Fast Ethernet ports will be transparent.
<i>As Router</i>	If you select the Router mode, the SIP phone will work as a router.
<i>--IP address</i>	User could configure the PC port IP address.
<i>--Subnet Mask</i>	User could configure the PC port Subnet Mask.
<i>--DHCP Server</i>	If you set the DHCP server on, the device connected to the PC port will get the IP address automatically between the start IP address and the end IP address. But if you select the bridge mode, the DHCP server cannot work.
<i>--Start IP Address</i>	Indicate the range of the IP address.
<i>--End IP</i>	Indicate the range of the IP address.

Address	
---------	--

To configure PC Port settings via Phone interface:

- 1) Press Menu->Setting->Advanced Settings.
- 2) Enter the password required, scroll to Network option, select PC Port option.
- 3) If you choose Bridge, set the PC's port as bridge mode, and then it will save and return to the previous menu.
- 4) If you choose Router, you will be prompted to enter the IP Address, Subnet Mask, DHCP Server Disable/Enable, etc.
- 5) Press Save soft key to save the changes.

To configure PC Port settings via Web interface:

Choose Network->Basic->LAN to do the relating configuration, you can consult your system administrator for more information.

The screenshot displays the Yealink web interface for configuring network settings. The 'Network' tab is selected, and the 'LAN' section is active. The 'As Bridge' option is selected under LAN, and the 'As Router' option is also visible. The LAN configuration fields are as follows:

Section	Option	Value
WAN	<input checked="" type="radio"/> DHCP	
	<input type="radio"/> Static IP Address	
	IP Address	
	Subnet Mask	
	Default Gateway	
	Primary DNS	202.101.103.55
Secondary DNS	202.101.103.54	
<input type="radio"/> PPPoE	User	
	Password	
LAN	<input checked="" type="radio"/> As Bridge	
	<input type="radio"/> As Router	
	IP Address	10.0.0.1
	Subnet Mask	255.255.255.0
	Enable DHCP Server	Enabled
	Start IP Address	10.0.0.10
End IP Address	10.0.0.100	

Buttons for 'Confirm' and 'Cancel' are located at the bottom of the configuration area. A 'NOTE' box on the right provides additional information: 'DHCP: The network configurations will be acquired from DHCP server.' 'Static IP Address: Specify the IP address, Subnet Mask, Default Gateway, Primary DNS, Secondary DNS fields manually.' 'PPPoE: Contact your ISP if it should be used.'

## Webserver Type

It is the definition of web access type and port. This IP phone can support HTTPS (Hypertext Transfer Protocol over Secure Socket Layer) and HTTP. Adding SSL layer under HTTP, in short, it is a security version of HTTP. Users can set this transmission mode via web page.

To configure HTTPS settings via Phone interface:

- 1) Press Menu->Setting->Advanced Settings.
- 2) Enter the password required, scroll to Network option, select Webserver Type



option.

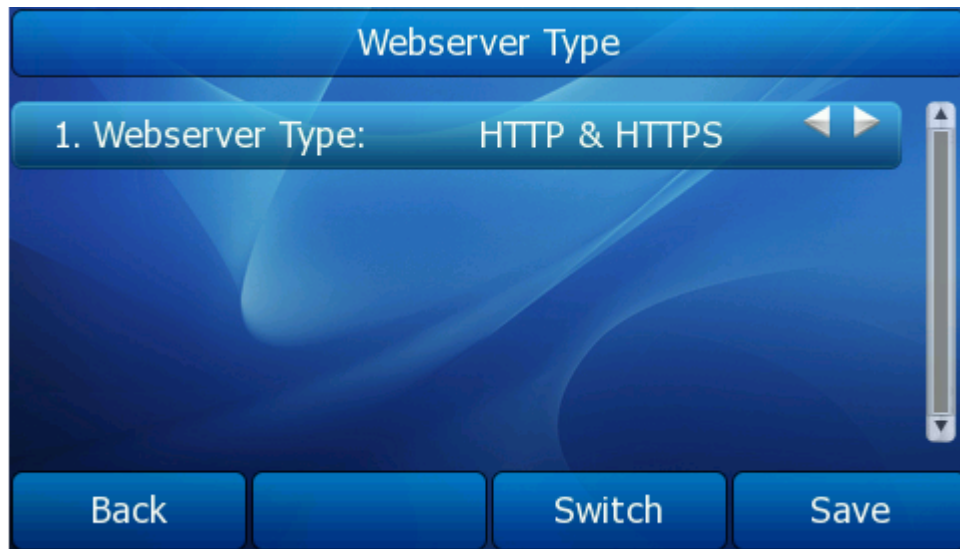

- 3) Press the navigation keys or Switch soft key to choose the transmission mode.
- 4) Press Save soft key to save the settings.

**Note:**

1. For more information/details about Webserver Type, please contact to your system administrator!
2. IP phone also support Internet Protocol Version 6.

To configure web server type via Web interface:

Go to Network->Advanced, choose WebServer option, in the pull-down menu of Type field, choose the transmission mode, and then click the Confirm button to save the changes.

	PC Port Link	auto negotiate
<b>VPN</b> ?	VPNActive	Disabled
	Upload VPN Config	<input type="text"/> 浏览...
		<input type="button" value="Import"/>
<b>Voice QoS</b> ?	Voice QoS	40 (0~63)
	SIP QoS	40 (0~63)
<b>Local RTP Port</b> ?	MaxRTPPort	11800 (2~65534)
	MinRTPPort	11780 (2~65534)
<b>WebServer</b> ?	HTTP port	80 (1-65535)
	HTTPS port	443 (1-65535)
	Type	HTTP&HTTPS
<b>802.1x</b> ?	802.1X Mode	Disabled
	Identity	<input type="text"/>
	MD5 Password	<input type="text"/>
<b>Registration random</b> ?	Registration random	0 (0-60s)
	<input type="button" value="Confirm"/>	<input type="button" value="Cancel"/>

## 802.1x Settings

IEEE 802.1X is an IEEE Standard for port-based Network Access Control (PNAC). It is part of the IEEE 802.1 group of networking protocols. It provides an authentication mechanism to devices wishing to attach to a LAN, either establishing a point-to-point connection or preventing it if authentication fails. It is used for securing wireless 802.1x access points and is based on the Extensible Authentication Protocol (EAP).

This IP phone can support 802.1X. For the details, please consult your system administrator.

To configure 802.1x Settings via Phone interface:

- 1) Press Menu->Setting->Advanced Settings.
- 2) Enter the password required, scroll to Network option, select 802.1x Settings option.
- 3) Choose enable/disable the 802.1x Mode.
- 4) Enter the Identity and MD5 Password.
- 5) Press Save soft key to save the settings.

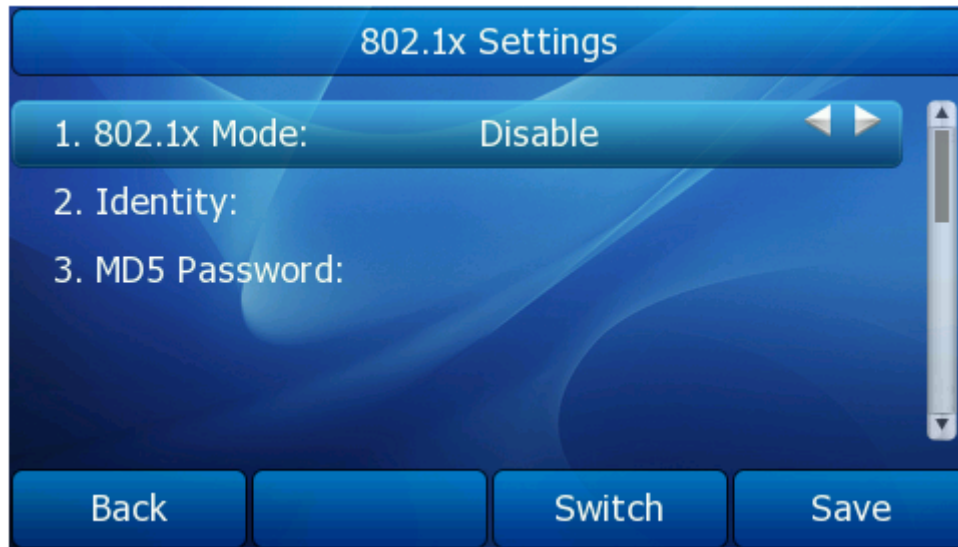

To configure 802.1x Settings via web interface:

Choose Network->Advanced->802.1x to do the relating configuration.

	PC Port Link	auto negotiate
<b>VPN</b> ?	VPNActive	Disabled
	Upload VPN Config	<input type="text"/> 浏览...
		<input type="button" value="Import"/>
<b>Voice QoS</b> ?	Voice QoS	40 (0~63)
	SIP QoS	40 (0~63)
<b>Local RTP Port</b> ?	MaxRTPPort	11800 (2~65534)
	MinRTPPort	11780 (2~65534)
<b>WebServer</b> ?	HTTP port	80 (1~65535)
	HTTPS port	443 (1~65535)
	Type	HTTP&HTTPS
<b>802.1x</b> ?	802.1X Mode	Disabled
	Identity	<input type="text"/>
	MDS Password	<input type="text"/>
<b>Registration random</b> ?	Registration random	0 (0~60s)
		<input type="button" value="Confirm"/> <input type="button" value="Cancel"/>

## VPN

A virtual private network (VPN) is a computer network that uses a public telecommunication infrastructure such as the Internet to provide remote offices or individual users with secure access to their organization's network. It aims to avoiding

an expensive system of owned or leased lines that can be used by only one organization.

It encapsulates data transfers using a secure cryptographic method between two or more networked devices which are not on the same private network so as to keep the transferred data private from other devices on one or more intervening local or wide area networks. There are many different classifications, implementations, and uses for VPNs.

If user want to enable VPN, user must import the VPN configure file via web interface at first.

Configure VPN via web interface:

- 1) Choose Network->Advanced->VPN.
- 2) Choose enable/disable this function.
- 3) User also can upload the configure file via web interface.
- 4) Click the Confirm button to save the changes.

The screenshot shows the Yealink web interface for configuring a phone. The 'Network' tab is selected, and the 'VPN' section is expanded. The configuration options are as follows:

Section	Parameter	Value	Range/Scope
LLDP	Active	Disabled	
	Packet Interval	120	(Scope:1~3600s)
VLAN	WAN Port Active	Disabled	
	VID	0	(0-4094)
	USRPRORITY	0	
PC Port	Active	Disabled	
	VID	0	(0-4094)
	USRPRORITY	0	
Port Link	WAN Port Link	auto negotiate	
	PC Port Link	auto negotiate	
VPN	VPNActive	Disabled	
	Upload VPN Config	[File Browser] [Import]	
Voice QoS	Voice QoS	40	(0~63)
	SIP QoS	40	(0~63)
Local RTP Port			

**NOTE**

**VLAN**  
A VLAN is a logical local area network (or LAN) that extends beyond a single traditional LAN to a group of LAN segments, given specific configurations.

**QoS**  
When the network capacity is insufficient, QoS could provide priority to users by setting the value.

**Local RTP Port**  
Define the port for voice transmission.

Configure VPN via phone interface:

- 1) Press Menu->Setting->Advanced Settings.
- 2) Enter the password required, scroll to Network option, select VPN option.
- 3) Press the navigation keys or Switch soft key to choose enable/disable VPN.
- 4) Press Save soft key to save the settings.



## Phone Setting

### *Contrast*

Through this function, user can adjust the expansion model-EXP39's contrast. Premise is the expansion model is connecting to the phone.

Configure Contrast via phone interface:

- 1) Press Menu->Setting->Advanced Settings.
- 2) Enter the password required, scroll to Phone Setting option, and select Contrast option.
- 3) Press the navigation keys or Switch soft key to choose contrast.
- 4) Press Save soft key to save the settings.



### *Lock*

You can lock the keypad of your phone when you are temporarily not using it. This

function helps you to protect your phone from unauthorized use. You can lock the following specific keys:

*Menu Key:* The Menu soft key cannot be used until unlocked. You cannot access the menu of the phone.

*Function Keys:* The hard function keys cannot be used until unlocked. You cannot access the MESSAGE, CONF, HOLD, MUTE, TRAN, RD, History, Directory, DND, OK, X, navigation Keys, etc.



*All Keys:* All of the keys cannot be used until unlocked. You can only use the phone to answer the incoming calls.

*Lock&Answer:* All the incoming calls will be put through automatically (Auto Answer), but cannot be hung up by your party.

To configure keypad lock via Phone interface:

- 1) Press Menu->Setting->Advanced Settings.
- 2) Enter the password required, scroll to Phone Setting option, and select Lock option.
- 3) Use the navigation key (or press the Switch soft key) to highlight the one you want to lock.



- 4) Press Save soft key to save the change.
- 5) The icon  will be displayed on the top right corner of the idle screen.
- 6) If you choose LOCK&ANSWER, it will show the icon  and  on the user interface.

To unlock the phone via Phone interface:

- 1) Press Menu soft key, you are prompted for the password.
- 2) Enter the password, and then press Enter soft key, the phone will be unlocked.
- 3) The icon will be disappearing from the idle screen.
- 4) If you choose Lock&Answer, you have to enter Menu->Setting->Advanced Settings->Phone Setting->Lock.

5) And then choose disable this option.

To configure keypad lock via Web interface:

Choose Phone->Preference-> Keyboard Lock to do the relating changes. Please refer to the instruction above for the parameters' detail.

Offset(minutes)	<input type="text"/>	
Manual Time	Disabled	?
Data	Year 2011 Month 04 Day 20	
Time	Hour 17 Minute 55 Second 17	
Time Format	24 Hour	?
Date Format	WWW MMM DD	?
Active Backlight Level	6	?
Inactive BackLight Level	Enabled	?
Backlight Time(seconds)	1min	?
PhoneTheme	Blue	?
Keyboard Lock	Disabled	?
WatchDog	Enabled	?
Ring Type	Ring1.wav	Del ?
Upload Ringtone	<input type="text"/> 浏览...	
	Upload Cancel	
WallPaper	pictures (06).png	Del ?
Load BgPicture	<input type="text"/> 浏览...	
	Upload Cancel	
ScreensaverTime(seconds)	1min	?
ScreenSaver	01.png	Del ?
Load Screensaver	<input type="text"/> 浏览...	
	Upload Cancel	
	Confirm	Cancel

**Note:**

1. The default password for unlock is **admin**.

## Reset to factory

You should reset the phone only in this case: the phone configuration was changed and the phone is not functioning anymore. To maintain the configuration of the phone, you need your system administrator or service provider's advice.

To reset to factory via phone interface:

- 1) Press Menu->Setting->Advanced Settings.
- 2) You are prompted to enter the required password, scroll to Reset to factory, press Enter soft key.
- 3) You are prompted to confirm the change, press OK soft key to reset to factory settings, press Cancel soft key to return to previous menu.
- 4) It will take a few minutes to reset, please do not power off during resetting, or it will cause flash memory error.



To reset to factory via Web interface:

- 1) Choose Phone->Upgrade.
- 2) Click Reset To Factory button.
- 3) You are prompted to confirm the change, press OK to confirm the changes, press Cancel to cancel the operation.

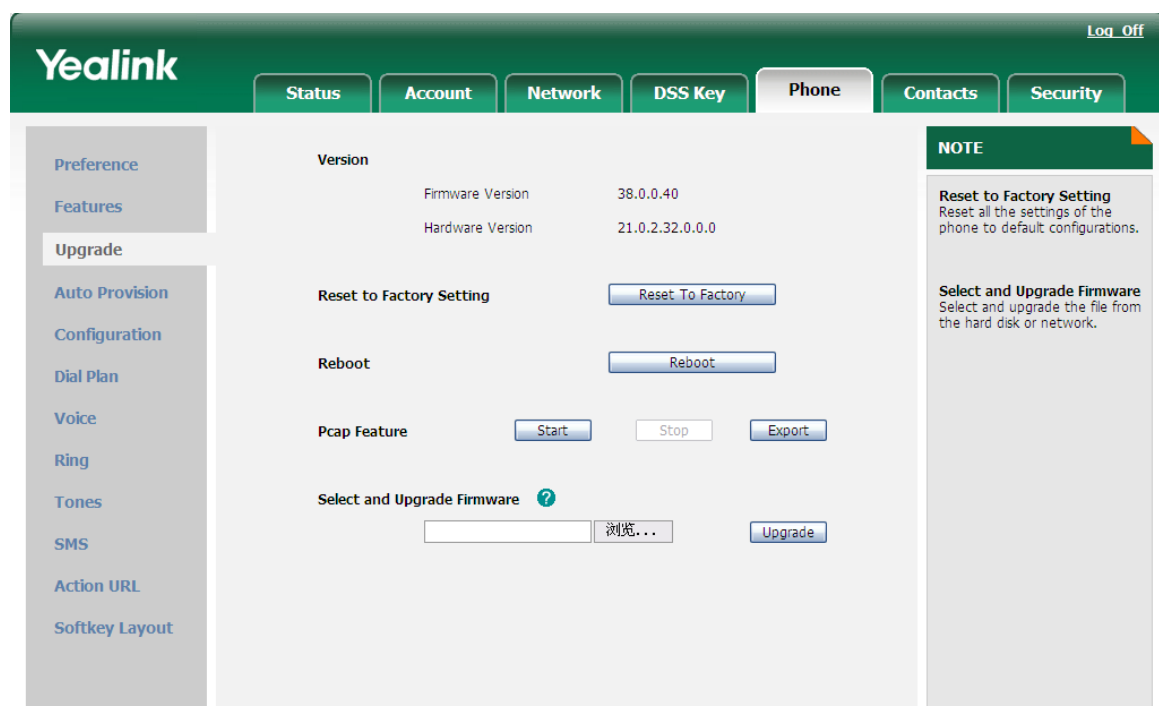

**Note:**

If you confirm to Reset to Factory, all the setting including contact list, call history, account setting, etc will be erased.

You have to export the configuration file first if you want to import the old configuration after Reset to Factory.



## SetPassword

To change the administrator password via Phone interface:

- 1) Press Menu->Setting->Advanced Settings.
- 2) You are prompted to enter the required password, scroll to Set Password, press Enter soft key.
- 3) You are prompted to enter the Current, New and Confirm password, press abc soft key to change the input method.



- 4) Press Save soft key to confirm the changes.

To change the administrator password via Web interface:

- 1) Choose Security->Password->admin, enter the Current, New and Confirm password.
- 2) Click Confirm button to save the changes, or Cancel button to cancel the changes.

## Set AES Key

If the downloaded configuration files have been AES encrypted, the AES Keys will be needed. The **Common AES Key** is for decrypting the Common CFG file. The **MAC-Oriented AES Key** is for decrypting the MAC-Oriented CFG file. The keys must be 16 bytes and the supported characters are: 0 ~ 9, A ~ Z, a ~ z and the following special characters: # \$ % \* +, - . : = ? @ [ ] ^ \_ { } ~

Configure AES key via phone interface:

- 1) Press Menu->Setting->Advanced Settings.
- 2) Enter the password required, scroll to Set AES Key option.
- 3) Input Common and MAC-oriented in the corresponding field.
- 4) Press Save soft key to save the changes.

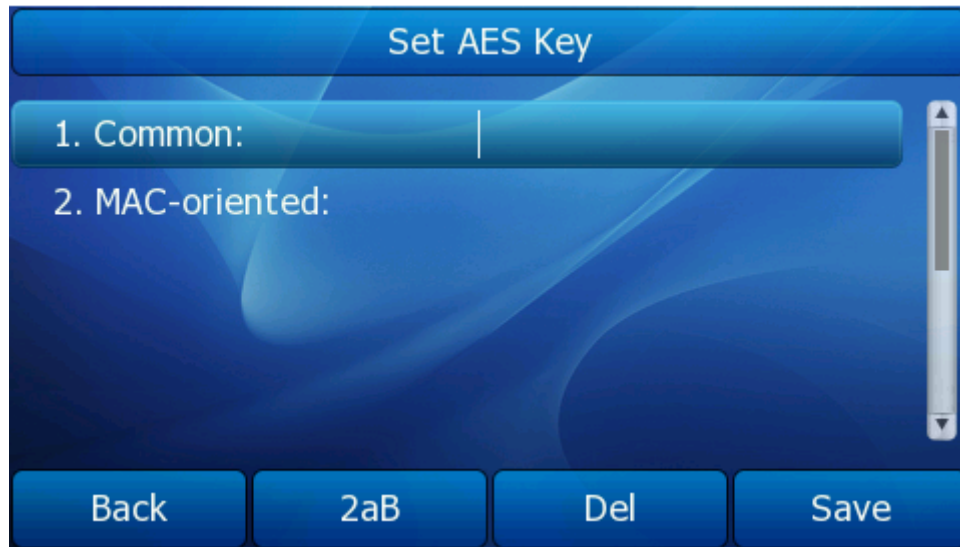

Configure AES key via web interface:

- 1) Choose Phone->Auto Provision-> Common AES Key/ MAC-Oriented AES Key
- 2) Enter the corresponding contents.
- 3) Click Confirm button to save the changes.

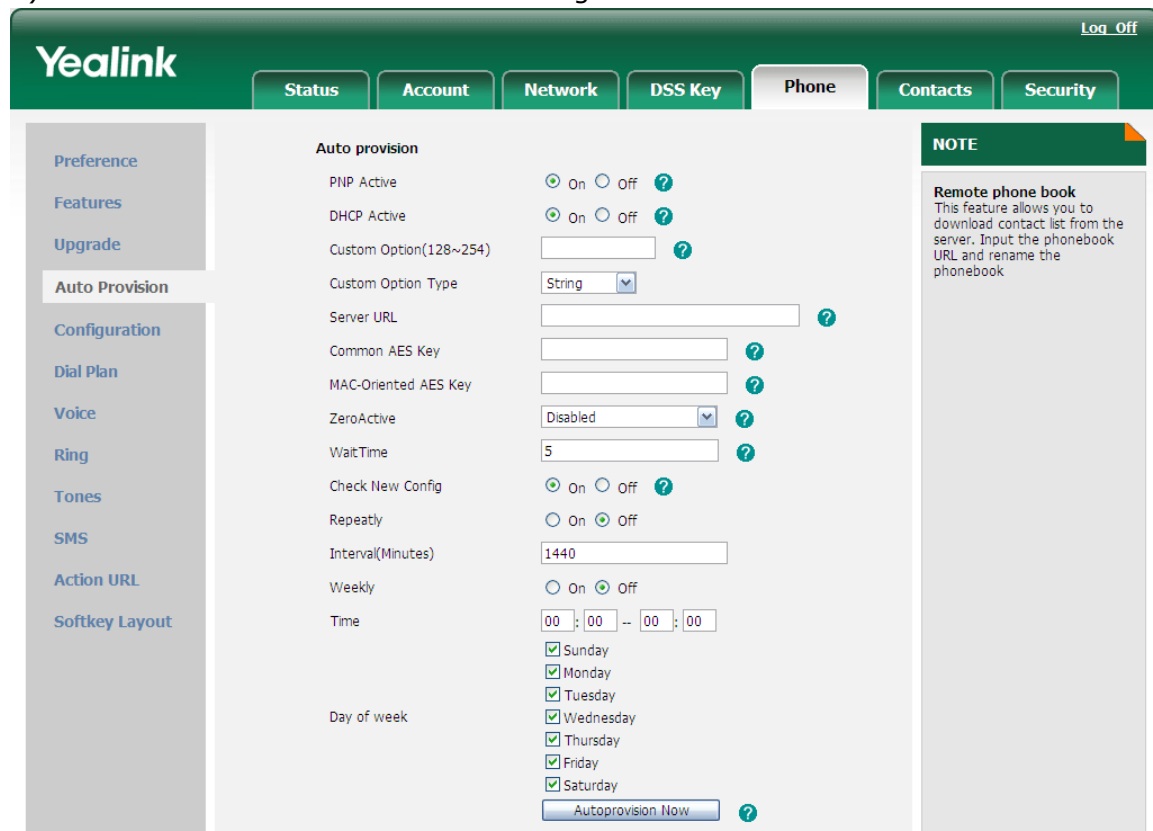

## Auto Provision

Configure Auto Provision via Web interface:

- 1) Choose Upgrade-> Auto Provision, configure the relating settings: Custom Option, Custom Option Type, URL, Account, Password, Common AES Key and

MAC-Oriented AES Key, PNP config and Check New Config.

- 2) Click Confirm button, the phone will check the server for a new firmware in a specific time, and it updates automatically if there is new firmware.
- 3) You can also update the firmware immediately by pressing Auto-provision button.

Set Auto Provision via phone interface:

- 1) Press Menu->Setting->Advanced Settings.
- 2) Enter the password required, scroll to Auto Provision option.
- 3) Enter the URL, User Name and Password.
- 4) Click the Save soft key to save the changes.



For more information about the parameters of the Auto Provision, you can consult your system administrator.



**Warning:**

Please do not power off or unplug the Ethernet cable during the updating. Any power interruption during the following process will most likely lead to a flash memory error. As a result the system cannot boot up anymore.

## Display

### WallPaper

Users can change the background picture.

Change the background picture via phone interface:

- 1) Press Menu->Display->WallPaper to enter the edit page.
- 2) Press Switch soft key to switch the background picture.
- 3) Press Save soft key to save the changes.



Configure WallPaper via Web interface:

- 1) Choose Phone->Preference.
- 2) Choose WallPaper.
- 3) Click Confirm button to save the changes.

User also can upload the background picture via web interface:

- 1) Choose Phone->Preference.
- 2) Choose Load BgPicture option, click browser button to choose the corresponding file.
- 3) Press Upload button to complete the operation.
- 4) Also can click the Del button to delete the file.

## Screensaver

Configure Screen Saver via phone interface:

- 1) Press Menu->Display->Screensaver to enter the edit page.
- 2) Press Switch soft key to Choose Screensaver Time.
- 3) Press the Save soft key to save the changes.
- 4) Also can choose Preview Screensaver Pictures option, and then press the Enter soft key to enter into the preview page.
- 5) Press Switch soft key to switch the photo to preview.

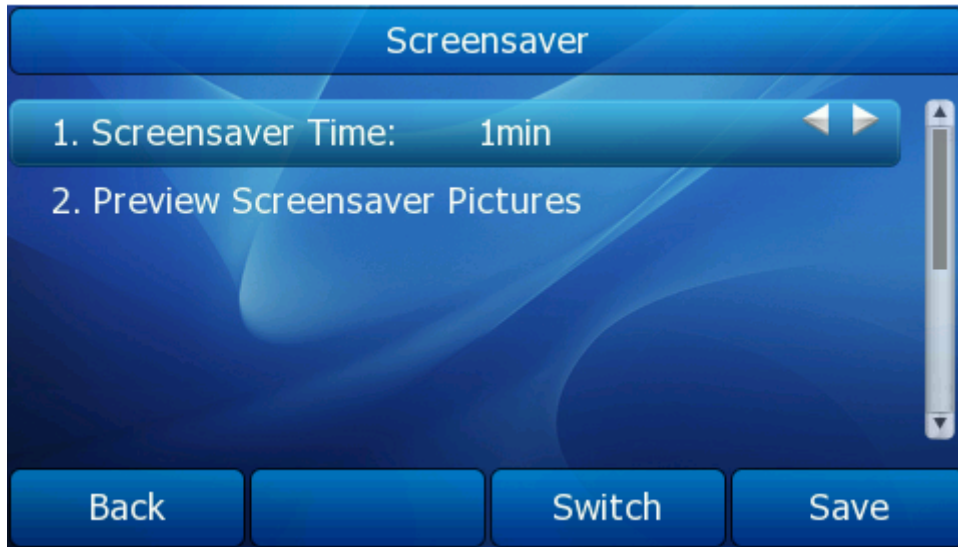

Configure Screen Saver via Web interface:

- 1) Choose Phone->Preference.
- 2) Configure ScreensaverTime and Screensaver in the corresponding field.
- 3) Click Confirm button to save the changes.

User also can upload the Screensaver file via web interface:

- 1) Choose Phone->Preference.
- 2) Choose Load Screensaver option, click browser button to choose the corresponding file.
- 3) Press Upload button to complete the operation.
- 4) Also can click the Del button to delete the file.

Note:

1. Only png, jpg and bmp format pictures can be supported.
2. If the upload pictures less than 480 x 272 pixels, it will display in the middle of the LCD, if the pictures more than 480 x 272 pixels, the pictures will be in proportion to dwindle and household display.
3. Only uploaded picture can be deleted.

## Theme

User can change the Theme via phone interface:

- 1) Press Menu->Display->Theme to enter the edit page.
- 2) Use navigation key to highlight an option.
- 3) Press the Save soft key to save the changes.

Theme 1	
Theme 2	
Theme 3	
Theme 4	

User also can change the Theme via web interface:

- 1) Choose Phone->Preference->Phone Theme.
- 2) Choose the theme in the drop-down menu.
- 3) Click Confirm button to save the changes.

Offset(minutes)	<input type="text"/>	
Manual Time	Disabled	?
Data	Year <input type="text" value="2011"/> Month <input type="text" value="04"/> Day <input type="text" value="27"/>	
Time	Hour <input type="text" value="11"/> Minute <input type="text" value="26"/> Second <input type="text" value="22"/>	
Time Format	24 Hour	?
Date Format	WWW MMM DD	?
Active Backlight Level	6	?
Inactive BackLight Level	Enabled	?
Backlight Time(seconds)	1min	?
PhoneTheme	Blue	?
Keyboard Lock	Disabled	?
WatchDog	Enabled	?
Ring Type	Ring1.wav	Del ?
Upload Ringtone	<input type="text"/> 浏览...	
	Upload Cancel	
WallPaper	pictures (06).png	Del ?
Load BgPicture	<input type="text"/> 浏览...	
	Upload Cancel	
ScreensaverTime	1min	?
ScreenSaver	01.png	Del ?
Load Screensaver	<input type="text"/> 浏览...	
	Upload Cancel	
Confirm		Cancel

## Backlight

User can set the backlight through this option.

Field	Description
Active Level	The backlight level when the phone is active.
Inactive Level	The backlight level when the phone is inactive. "0" is stand for black, "1" is stand for gray.
Backlight Time	If the user in "backlight" time does not do any operations, the phone will automatically get into an energy saving mode.

Configure these options via phone interface:

- 1) Press Menu->Display->Backlight to enter the configure page.
- 2) Use navigation key to highlight an option.
- 3) Press Switch soft key to configure.
- 4) Press the Save soft key to save the changes.



## Applications

### Digital Photo Frame

Through this function user can preview the screen savers effect.

- 1) Press Menu->App->Digital Photo Frame.
- 2) Use navigation key to choose the photo, if you have enough permissions, you can press the Remove soft key to delete this photo.
- 3) User also can press the Play soft key to use the Digital Photo Frame function.
- 4) Press any key to exit.

**Note:**

User the digital photo frame, the phone equivalent to enter screensavers status. User can press any key to exit the screensavers status.



## Other Settings





### Codec Selection

The IP phone supports the following voice codecs:

G723\_63, G722, G726-16, G726-24, G726-32, G726-40, PCMA, G729, PCMU, and G723\_53.

You can enable/disable the desired codecs via Web interface. Please contact your System Administrator for more details about the codecs.

To enable/disable the codecs:

- 1) Choose Account->Codec.
- 2) Choose an account.
- 3) Use the navigation keys to highlight the desired one in the Enabled/Disable Codecs list, and press the  /  to move to the other list. press the  /  to select priority
- 4) Click Confirm to save the change.

**Note:**

Codec selection can only be set via Web interface.

### Auto Answer

Auto-answer allows an incoming call to be answered without requiring any action by the user. This is a useful feature for people who have difficulty in using their hands or fingers, who have a visual impairment, or who have a cognitive impairment. You can set this function to a special account.

To set Auto Answer via the IP phone interface:

- 1) Press Menu->Setting->Advanced Settings, enter the password and press enter soft key.
- 2) Then choose Accounts, highlight a line, press enter soft key to the configuration page, use the navigation keys to choose Auto Answer option.
- 3) Press the Switch soft key to enable or disable the auto answer function. The default is Disabled.
- 4) Press the Save soft key to save the changes.

To set Auto Answer via Web interface:

- 1) Choose Account-> Basic-> Auto Answer.
- 2) Choose Enabled or Disabled in the pull-down menu, click Confirm button to save the change.

## Missed call log

Defines whether to save the missed calls to the call history record. This function can only be set via the Web interface:

- 1) Choose Account-> Basic->Missed call log.
- 2) Choose Enabled or Disabled in the pull-down menu, click Confirm button to save the change.

## Programmable Key

The soft keys, navigation keys and function keys on the keypad are editable. Users can customize specific features for these keys according to their actual needs.

This function can only be set via the Web interface:

- 1) Choose DSS Key->Programmable Key.





Key	Type	Line	Value
SoftKey1	History	History	
SoftKey2	Directory	Auto	
SoftKey3	DND	Auto	
SoftKey4	Menu	Auto	
Up	History	History	
Down	Directory	Auto	
Left	Switch Account Up	Auto	
Right	Switch Account Down	Auto	
OK	Status	Auto	
Cancel	N/A	Auto	
CONF	N/A	Auto	
HOLD	N/A	Auto	
MUTE	N/A	Auto	
TRAN	Forward	Auto	

- 2) Choose and customize specific features for these keys.
- 3) Click Confirm button to save the changes.

## Softkey Layout

The phone can support 12 kinds of call interface to set up softkey, user can setup different function key according to his/her own requirement or habit.

To set up softkey via web interface:

- 1) Choose Phone->Softkey Layout.
- 2) In the "Custom Softkey" field, chose Enable in the pull-down menu.
- 3) You can choose the corresponding call states which you want to set up the softkey in the Call States field.
- 4) Highlight the desired one in the Unselected Softkeys/Selected Softkeys list, and press the  /  to move to the other list.
- 5) And you can use  /  to choose the order how to display in the call states.
- 6) Click Confirm to save the changes.
- 7) You can also click the Reset to Default button to reset the softkeys interface.

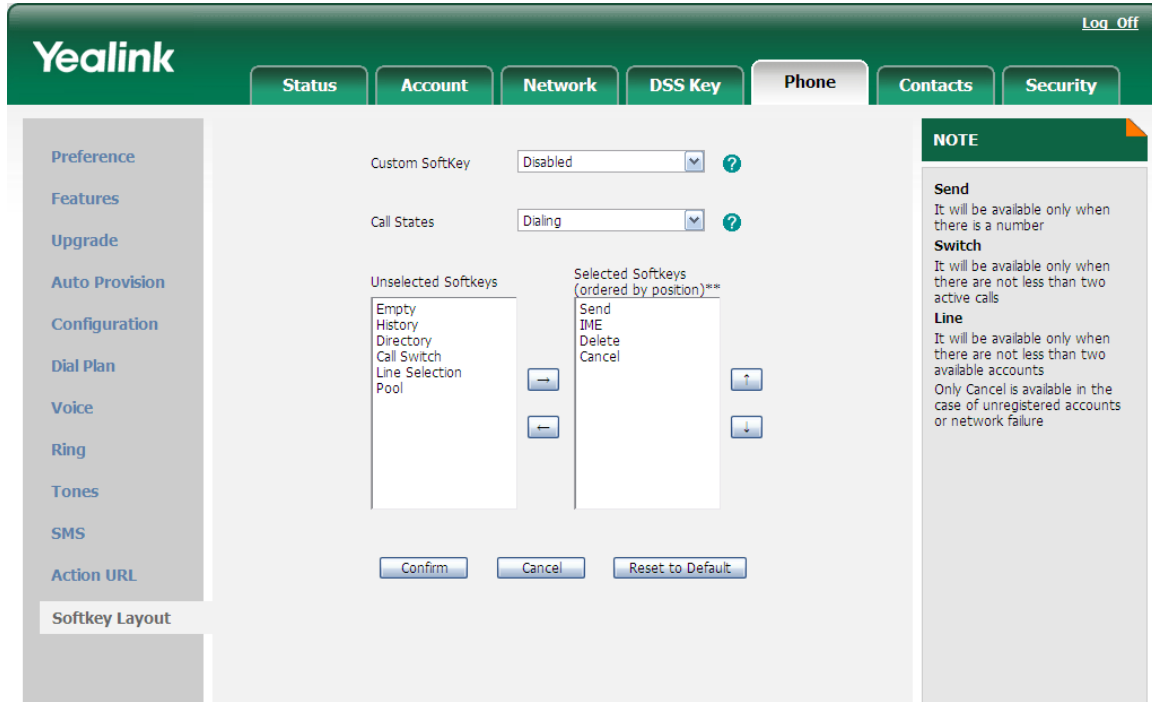

**NOTE**

**Send**  
It will be available only when there is a number

**Switch**  
It will be available only when there are not less than two active calls

**Line**  
It will be available only when there are not less than two available accounts  
Only Cancel is available in the case of unregistered accounts or network failure

**Note:**

We can add the Empty key more than once, but others can only be chose once, and can't be repeat. If you have set up more than 4 soft key options, the fourth soft key option that showed on the LCD will automatically turn to be "More". Press "More" it will switch to the next page for which it will show the other soft key options.

## Live Dialpad

Defines whether to dial out the dialed number automatically.

This function can only be set via the Web interface:

- 1) Choose Phone->Feature->Live Dialpad.
- 2) Enable or disable it in the pull-down menu.
- 3) Set the time in the Inter Digit Time field.
- 4) Click Confirm button to save the change.

**Yealink** Log Off

Status Account Network DSS Key **Phone** Contacts Security

Preference  
Features  
Upgrade  
Auto Provision  
Configuration  
Dial Plan  
Voice  
Ring  
Tones  
SMS  
Action URL  
Softkey Layout

**Forward: ?**

**Always**  On  Off

Target  ?

On Code  ?

Off Code  ?

**Busy**  On  Off

Target  ?

On Code  ?

Off Code  ?

**No Answer**  On  Off

After Ring Time(seconds)  ?

Target  ?

On Code  ?

Off Code  ?

**General Information:**

Live Dialpad  ?

Inter Digit Time(1~14)(seconds)  ?

Call Waiting  ?

Call Waiting Tone  ?

Auto redial  ?

Auto redial interval(1~300s)  ?

**NOTE**

**Forward**  
This feature allows you to forward an incoming call to another phone number.

**Target**  
The number to which the incoming calls will be forwarded.

**On Code**  
The code that will be sent to PBX when it is switched On.

**Off Code**  
The code that will be sent to PBX when it is switched Off.

**Call Waiting**  
This call feature allows your phone to accept other incoming calls during the conversation.

**Key As Send**  
Select \* or # as the send key.

**Hotline Number**  
When you pick up the phone, it will dial out the hotline number automatically.

**Upload Logo**  
The picture must be format of jpg, it can be black and white, or 2 gray scale.

## Dial Plan

### Replace Rule

A dial plan establishes the expected number. This includes country codes, access codes, area codes and all combinations of digits dialed. For example if you set the *Prefix* as 0 and *Replace* as 0086, when you dial 0 out, the number will be replaced by 0086 automatically.

To set a Replace Rule via the Web interface:

- 1) Choose Phone->Dial Plan->Replace Rule.
- 2) Enter the desired *Prefix*, *Replace* and *Account*.
- 3) Press Add button to save the changes.
- 4) You can also delete a specific one from the dial plan list.
- 5) You can select a record to modify, then click Edit button to submit.

### Dial Now

Dial-now enables you to define the specific length of any number/letter in advance(for example xxx), next time when users dial out the 123 whose length matches the Dial-now rule, the phone will dial out 123 in one second without pressing Send button.

To set a Dial Plan via the Web interface:

- 1) Choose Phone->Dial Plan->Dial now.

- 2) Enter the number in Dial-now Rule and Account.
- 3) Press Add button to save the changes.
- 4) You can select a record to modify, then click Edit button to save.
- 5) You can also delete a specific one from the dial plan list by pressing Del button.
- 6) You can also set the Time Out for Dial-now Rule via web interface. Choose Phone->Features->Time Out for Dial-now Rule, enter the time.

**Note:**

1. If need to replace the unknown contents, then you can use (.) or (x), "." stand for a string of char, "x" stand for any one char. The content in ( ) stand for a variable, the first variable is expressed by \$ 1, the second variable is expressed by \$ 2, the rest can be done in the same manner. For example: if you want to replace the any input content with the content beginning with 8. Input (.) in Prefix box, and input 8\$1 in Replace box.

## Area Code

Area codes are also known as Numbering Plan Areas (NPAs). These are necessary (for the most part) only when dialed from outside the code area and from mobile phones. Area codes usually indicate geographical areas within one country, although the correlation to geographical area is becoming obsolete. For non-geographical numbers, as well as mobile telephones outside of the United States and Canada, the "area code" does not correlate to a particular geographic area.

To add the area code via the Web interface:

- 1) Choose Phone->Dial Plan->Area Code.
- 2) Enter the Code and Account, set the Min Length and the Max Length option, and then click the Confirm button to save.

## Block Out

The specific phone numbers can be forbidden to be call out from your IP phone.

- 1) Choose Phone->Dial Plan->Block Out.
- 2) Enter Block Out Number and Account, click Add button to save the changes, or choose the specific one in the list, click Delete button to delete the record.
- 3) You can select a record to modify, then click Edit button to submit.
- 4) You cannot dial out the number from your IP phone unless it is removed from the forbidden list.

**Note:**

The numbers set in Emergency cannot use the dial plan rule.

**Note:**

1. In the Account field, you can enter 1,2,3..., "1" represents Account 1, "2" represents Account 2 ..... , if the account box is empty, it mean this rule works for all accounts .

## Feature Synchronisation

When enabled the synchronize function, configure the DND/FWD function on device or server, DND/FWD status on device and server will be in correspondence.

To set Feature Key Synchronisation via the Web interface:

- 1) Choose Phone->Features-> Feature Key Synchronisation.
- 2) Choose whether to enable this function from the pull-down menu.
- 3) Click the Confirm to save the change.

Return code when refuse	486 (Busy here)	?
Return code when DND	480 (Temporarily not av	?
DND On Code		?
DND Off Code		?
Allow Intercom	Enabled	?
Intercom Mute	Disabled	?
Intercom Tone	Enabled	?
Intercom Barge	Enabled	?
Enable Semi-Attend Transfer	Enabled	?
Call Completion	Disabled	?
Blind Transfer OnHook	Enabled	?
Attend Trans OnHook	Enabled	?
Transfer on Conference Hang up	Disabled	?
Feature Key Synchronisation	Disabled	?
Time Out for Dial-now Rule	4	?
ACD Auto Available	Disabled	?
ACD Auto Available Timer(0~120s)	60	?
RFC 2543 Hold	Disabled	?
Use Outbound Proxy In Dialog	Enabled	?
IsDeal180	Enabled	?
SaveCallHistory	Enabled	?
DTMFRepetition	3	?

## WatchDog

When 'WatchDog' function is 'Enabled', phone will auto reboot after 10 seconds if some important process of phone crash. When 'Disable' the function, the phone will not reboot.

Configure watchdog via web interface:

Choose phone-> Preference->WatchDog, in the pull-down menu, choose enable or disable this function.

## Action URL/URI

Action URL: Record the operation of phone, send this corresponding information to

server; action URI: Remote control phone for corresponding operation.

### Action URL:

The operation can be recorded include: Setup Completed, Log On, Log Off, Register Failed, Off hook, On hook...etc.

Set Action URL via web interface:

- 1) Choose Phone->Action URL
- 2) Enter the Corresponding contents.
- 3) Click Confirm to save the changes.

Event	Action URL	Help
SetupCompleted	<input type="text"/>	?
LogOn	<input type="text"/>	?
LogOff	<input type="text"/>	?
RegisterFailed	<input type="text"/>	?
Offhook	<input type="text"/>	?
Onhook	<input type="text"/>	?
IncomingCall	<input type="text"/>	?
OutgoingCall	<input type="text"/>	?
CallEstablished	<input type="text"/>	?
CallTerminated	<input type="text"/>	?
Open DND	<input type="text"/>	?
Close DND	<input type="text"/>	?
Open Always Forward	<input type="text"/>	?
Close Always Forward	<input type="text"/>	?
Open Busy Forward	<input type="text"/>	?
Close Busy Forward	<input type="text"/>	?
Open No Answer Forward	<input type="text"/>	?
Close No Answer Forward	<input type="text"/>	?
Transfer call	<input type="text"/>	?
Blind transfer call	<input type="text"/>	?
Attended transfer call	<input type="text"/>	?

The format of http URL is like this: <http://internal.server.net/help.xml?>

This URL can be user defined. Replace internal.server.net by the server IP address.

### The variable URL supported:

\$mac	#MAC address
\$ip	#IP address
\$model	# model of the phone
\$firmware	# firmware of the phone
\$active_url	#SIP URI of current active account(when Imcoming call, Outgoing call, Call established)
\$active_user	#User account part of SIP URI from current active account(when Imcoming call, Outgoing call, Call established)
\$active_host	#Server part of SIP URI from current active account(when Imcoming call, Outgoing call, Call established)
\$local	#SIP URI of Callee(when Imcoming call, Outgoing call)
\$remote	#SIP URI of Caller(when Imcoming call)
\$display_local	#Display name of Callee(when Imcoming call, Outgoing call)

\$display_remote	#Display name of Caller(when Imcoming call)
\$call_id	#call_id (when Imcoming call, Outgoing call, Call established)

**Active URI:**

Enter the "<http://Phone IP/cgi-bin/cgiServer.exx?key=xxx>" in Browser address bar, the phone will realizing the corresponding function. If you not login the web with the user name and password, you will need to specify the user/password to confirm the operation. The username/password can be added into the URI like:

<http://admin:admin@10.2.3.25/cgi-bin/cgiServer.exx?key=OK>

Our phone can support the following functions function:

Key=xxx stand for the following rules:

To answer the call: key=OK/key=ENTER

To turn on speaker mode: key=SPEAKER

Press transfer button: key=F\_TRANSFER

Increasing the volume: key=VOLUME\_UP

Reduce the volume: key=VOLUME\_DOWN

To mute the call: key=MUTE

To hold the call: key=F\_HOLD

To end the call: key=X (during the conversation)

To enter the DTMF number(include Numeric , \* or # keys): key=0-9/\*/POUND

Press a line key: key=L1-L6

Press a DSS key: key=D1-D10

Press Conference button: key=F\_CONFERENCE

Press a soft key: key=F1-F4

Press Message button: key=MSG

Press Headset button: key=HEADSET

Press RD button: key=RD

Press navigation key: key=UP/ DOWN/ LEFT/ RIGHT

To reboot the phone: key=Reboot

To check the Auto provision: key=AutoP

To enable DND: key=DNDOOn

To disable DND: key=DNDOff

Dial out:

[http://Phone IP/cgi-bin/cgiServer.exx?number=NUMBER&outgoing\\_uri=URI](http://Phone IP/cgi-bin/cgiServer.exx?number=NUMBER&outgoing_uri=URI)

Phone IP stand for the phone's IP address. NUMBER stand for the number which you want to send. URI stand for the account.

For example:

[http://10.2.3.25/cgi-bin/cgiServer.exx?number=0599123456&outgoing\\_uri=216@192.168.1.199](http://10.2.3.25/cgi-bin/cgiServer.exx?number=0599123456&outgoing_uri=216@192.168.1.199)

**Notes:**

1. The URI is case sensitive.
2. If you test it via web browser, you will need to specify the user/password to confirm



the operation for the first time. The username/password can be added into the URI like: <http://admin:admin@10.1.4.148/cgi-bin/ConfigManApp.com?key=6>.

3. If there is no account as specified, the phone will dial out with the default extension number. If there is no any account, the phone will dial out as IP dialing.

## XML-IdleScreen

The phone allows users to specify distinct idle screen for each line. The phone will always display the idle screen of the currently active line. The idle screen is using XML format. The idle screen can have different background images as well.

There are six elements (Background picture, Clock, Data, State, Soft key) you can custom the idle screen by yourself.

Configure XML-IdleScreen via web interface:

- 1) Choose Account->Basic->XMLIdleScreen Active, choose Enable or Disable this function.
- 2) If you want to use this function, and then you must input the URL in the XmlIdleScreen URL field.
- 3) Click the Confirm button to save the changes.

### Note:

- 1) XML-IdleScreen only used to idle interface.
- 2) For more information about the XML file and the URL you can consulting your system administrator

Password	.....	?	
SIP Server	10.2.1.199	Port	5060 ?
Enable Outbound Proxy Server	Disabled	?	
Outbound Proxy Server		Port	5060 ?
Transport	UDP	?	
Backup Outbound Proxy Server		Port	5060 ?
NAT Traversal	Disabled	?	
STUN Server		Port	3478 ?
Voice Mail		?	
Proxy Require		?	
Anonymous Call	Off	?	
On Code		?	
Off Code		?	
Anonymous Call Rejection	Off	?	
On Code		?	
Off Code		?	
Missed call log	Enabled	?	
Auto Answer	Disabled	?	
XMLIdleScreen Active	Disabled	?	
XmlIdleScreen URL		?	
Ring Type	common	?	

service provider.

**NAT Traversal**  
Defines the STUN server will be active or not.

**Proxy Require**  
A special parameter just for Nortel server. If you login to Nortel server, the value should be: com.nortelnetworks.firewall

**Codecs**  
Choose the codecs you want to use.



**Advanced**  
The Advanced parameters for administrator.

# Using the Basic Call Functions

## Making a call

### Call Devices

You can make a phone call via the following devices:

- 1) Pick up the handset, icon  will be shown in the idle screen.
- 2) Press the Speaker button, icon  will be shown in the idle screen.
- 3) Press the Headset button if the headset is connected to the Headset port in advance.

In the dial-up interface, the icon  will be shown in the idle screen.

Then enter the number, press Send soft key to dial out.

You can also dial the number first, and then choose the method you will use to speak to the other party.

### Call Methods

You can dial the number directly by filling the SIP Server in the registered interface. But the number which you dialed must be the same with SIP server.

If you have registered more than one account, you can choose a certain account to make your call:

- 1) Press the Left/Right navigation key to choose a default account when your phone is in idle status.
- 2) In the dial-up interface, press the Line soft key to choose an account. Then press the Select soft key to confirm.
- 3) Press the six line keys on the keypad to active the chosen account.

Then

- 1) Dial the number you want to call, or
- 2) In dial-up interface, press Pool soft key, use the navigation button to highlight your choice, enter into the corresponding option or
- 3) Press the RD button in the idle status to enter the Dialed Calls interface, then use the Up/Down navigation keys to choose a record.

- 4) Press the DSS keys which have been set as speed dial button.

Then press Send soft key to make the call out if necessary.

And you can also dial-up via web interface:

- 1) Choose Contacts-> Contacts -> Contacts/BlackList, click the number which you want to dial out, the phone will dial out.

The screenshot shows the Yealink web interface. At the top, there is a green header with the Yealink logo and a 'Log Off' link. Below the header is a navigation bar with tabs for Status, Account, Network, DSS Key, Phone, Contacts, and Security. The 'Contacts' tab is selected, and the 'BlackList' sub-tab is active. A 'Hangup' link is visible in the top right of the main content area.

The main content area features a table with the following columns: Index, Display Name, Office Num, Mobile Num, Other Num, Line, and a checkbox. The table contains one row with Index 1, Display Name 'aa', Office Num '123', Mobile Num '123', Other Num '123', and Line 'Auto'. Below the table are buttons for 'Save', 'Del', and 'Move To Black List'.

Below the table is a 'Contacts' form with fields for Name, Office Num, Mobile Number, Other Num, Account (Auto), Ring (Auto), Group (Not In Group), and Photo (Default). There is also a 'Delete Photo' button and an 'Upload Photo' button with a file selection field.

On the right side, there is a 'NOTE' section with the following instructions:

- Add Contact/Blacklist**: Fill out the contact information. User shouldn't leave contact name blank.
- Delete Contact/Blacklist**: Select the contact you want to delete in the grid, and then press the button Delete to confirm.
- Move to Contact/blacklist**: Choose the contacts you want to move in the grid, and press the button move to Contact/Blacklist to move it.
- Import**: Browse the file in XML format.
- Export**: Click Export button and create a file with whose name you prefer to export.

On the left side, there is a sidebar menu with links for Contacts, Remote Phone Book, Phone Call Info, LDAP, Broadsoft, and Calllog.

- 2) Or choose Contacts->Phone CallInfo, enter the number in the Dial a Number field, select the line from the Outgoing Identity list. Then click the Dial button to call out.
- 3) Or choose Contacts->Phone CallInfo, click the number which you want to dial out from the call list, the phone will dial out.
- 4) You can click the Hangup button to end the call in the web page.

The screenshot shows the Yealink web interface. At the top, there is a green header with the Yealink logo and a 'Log Off' link. Below the header are several navigation tabs: Status, Account, Network, DSS Key, Phone, Contacts, and Security. The 'Contacts' tab is currently selected. On the left side, there is a sidebar with links for Contacts, Remote Phone Book, Phone Call Info, LDAP, Broadsoft, and Calllog. The main content area is titled 'Call Panel' and contains a 'Dial a Number' input field, a 'Dial' button, and a 'Hangup' button. Below this is an 'Outgoing Identity' dropdown menu showing '0599111@10.2.1.199'. Underneath is a table with four tabs: 'Dialed List', 'Missed List', 'Received List', and 'Forwarded List'. The 'Dialed List' tab is active, showing a table with the following data:

Index	Data	Time	Local Identity	Name	Tel Number
1	Wed Apr 20	19:17	0599111@10.2.1.199		<a href="#">2@10.2.1.199</a>

On the right side of the interface, there is a 'NOTE' section with a green header and a sub-header 'Contacts-CallInfo Note'.

## Answering a call

### Answering an incoming call

- 1) If you are not on an active call, lift the handset to answer it using the handset, or press the Speaker button to answer it using the speakerphone, or press the headset button to answer it using the headset.
- 2) If you are on an active call, the LCD will prompt to display: *Incoming Call: xxx*. Press Answer soft key to answer the call, or Reject soft key to refuse it.

During the conversation, you can alternate between Headset, Handset and Speaker mode by pressing the corresponding buttons or picking up the handset.

### Denying an incoming call

Press Reject soft key or X button to deny the incoming call directly.

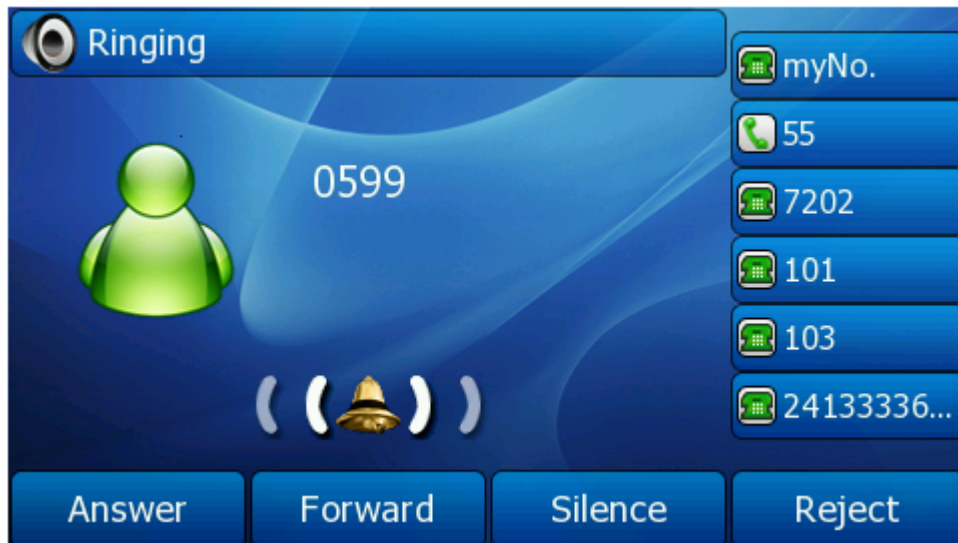

## DND

Press DND soft key to active DND Mode. Further incoming calls will be rejected and the display shows:  icon. Press DND soft key again to deactivate DND mode. You can find the incoming call record in the Call History.

User also can use DND code. For more information about DND, you can refer to "[DND Code](#)"

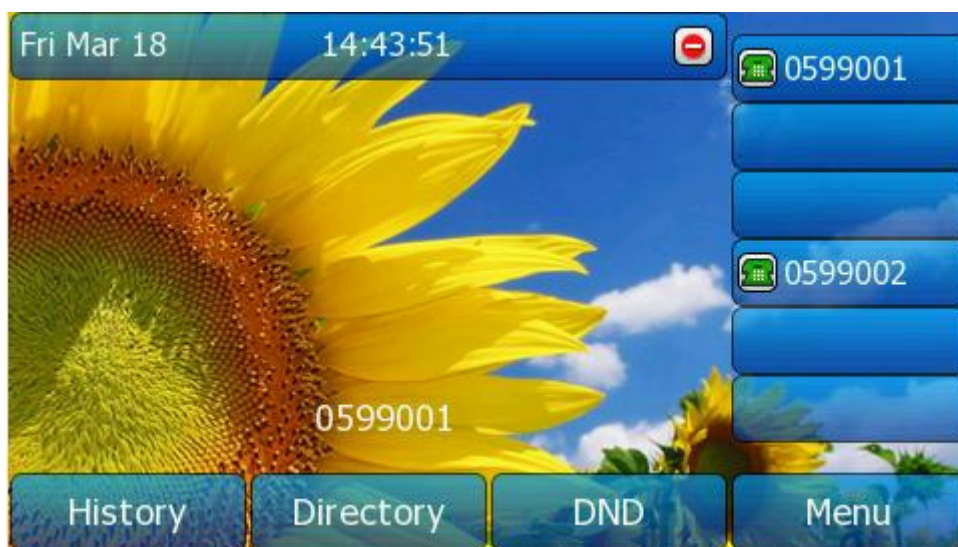

## Call Forward

This feature allows you to forward an incoming call to another phone number e.g. a cell phone or voice mailbox. For more information, user can refer to "[Call Forward](#)".

## During an Active Call

### Mute

This function allows you to mute the microphone of the active audio device during a call; you cannot be heard by the other party. You can still hear all other parties while mute is enabled. When you press the MUTE button all of the conversation will be muted.

To mute/resume a conversation:

Press MUTE button during a conversation, the icon  will be shown in the LCD. Press it again to get the microphone return to normal conversation.

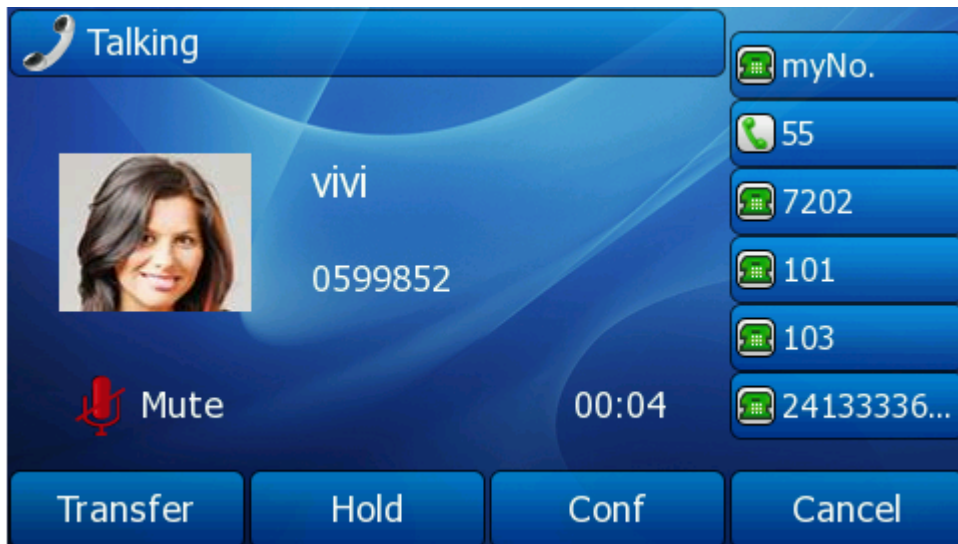

### Call Hold

This call function allows you to place an active call on hold. In this case your IP PBX might play a melody or message to the other party while waiting. Other calls can be received and made while having a call on hold.

To hold/retrieve a call:

- 1) Press the HOLD button or Hold soft key to put your active call on hold.
- 2) During the call, there will be a "dodo..." sound for each 30 second, suggesting that there is a current call in Hold state.
- 3) If there is only one call on hold, press the Resume soft key or HOLD button to retrieve the call.
- 4) If there are more than one call on hold, press the Up/Down navigation key to highlight the call, then press the Resume soft key or HOLD button to retrieve the

call.



## Call Waiting

This call feature allows your phone to accept other incoming calls to the extension no matter under which circumstances. For more information, user can refer to "[Call Waiting](#)".

## Call Transfer

You can customize your phone so that incoming calls are transferred directly to the third party such as another extension, mobile phone number, etc. There are three ways to transfer the call: Blind Transfer, Attended Transfer and Semi-Attended Transfer.

To Blind Transfer via phone interface:

- 1) A and B is on an conversation, A press TRAN Button or Tran soft key to put B on hold, then A can dial the third telephone number C and press the Tran soft key to call out. A will turn to hold status, and the LCD will display as Transferred.
- 2) After C answered it, or A press the Cancel soft key to complete the transfer.
- 3) A will be disconnected from the call. B can talk to C.

To Attended Transfer via phone interface:

- 1) A and B is on an conversation, A press TRAN Button or Tran soft key to put B on hold, then A can dial the third telephone number C and press the OK or SEND button to call out.
- 2) After C answered it, A and C can have a private conversation without B hearing, then A press the TRAN button to complete the transfer.
- 3) A will be disconnected from the call. B can talk to C.

To Semi-Attended Transfer via phone interface:

- 1) A and B is on an conversation, A press the TRAN button or Tran soft key to put B on hold, then A can dial a new number C and press the OK or SEND button to call out.
- 2) While C is ringing, A hang up or press the Transfer soft key. Then A will turn to hold status, and the LCD will display as Transferred.
- 3) A will be disconnected from the call, when C pick up, B can talk to C.

## Local Conference

You can establish a three-party conference, during the conversation three phone parties can communicate with each other. Use this function must enable this option via web interface.

To enable local conference via web interface:

- 1) Choose Account->Account X->Advance->Conference Type, there is a pull-down menu, choose Local Conf from the list.
- 2) Press Confirm button to save the changes.

To establish a local conference:

- 1) Press the Conf soft key during an active call.
- 2) The first call is placed on hold. You will hear a dial tone. Dial the number to conference in, then press the Send soft key.
- 3) When the call is answered, you can have a private conversation at first. And then press the CONF button, the conference call will include you and the other two parties.
- 4) During the conference, press the Split soft key to split the conference into two hold lines, and press the Resume soft key to resume the chosen call respectively.
- 5) When you press the hold key, the conference will be on hold.
- 6) Hang up to disconnect all parties.





## Network Conference

If you want to make a conference with more than three people, you can open the function of network conference. This function needs the server's support.

If you enabled this function, you can put the meeting conference on the server.

To enable network conference via web interface:

- 1) Choose Account->Account X->Advance->Conference Type, there is a pull-down menu, choose Network Conf from the list.
- 2) Enter the Conference URI in the Conference URI field.
- 3) Press Confirm button to save the changes.

To establish a network conference:

- 1) Press the Conf soft key during an active call.
- 2) Dial the number to conference in, then press the Send soft key
- 3) When the call is answered, press the CONF button.
- 4) After starting a three way conference, press Conf button to enter Conference dialing interface and invite another party to participate in teleconference.
- 5) After starting conference, press Hold key to Hold local call without influencing others in conference.

Use Session Timer	Disabled	?
Session Timer(seconds)		?
Refresher	Uac	?
Use user=phone	Disabled	?
Voice Encryption(SRTP)	Disabled	?
ptime(ms)	20	?
BLF List URI		?
BLF List Code		?
Shared Line	Disabled	?
Dialog-Info Call Pickup	Disabled	?
BLA Number		?
BLA Subscription Period BSP_Scope	300	?
SIP Send MAC	Disabled	?
SIP Send Line	Disabled	?
SIP Registration Retry Timer (Scope:0~1800)(seconds)	30	?
Enable Signal Encode	Disabled	?
Signal Encode Key		?
Conference Type	Local	?
Conference URI		?
ACD Subscription Period(120~3600)	3600	?
SubscribeMWIToVM	Disabled	?
SIPServerType	Default	?
<input type="button" value="Confirm"/> <input type="button" value="Cancel"/>		

# Using the Advanced Phone Functions

## Account Settings

Please refer to the previous part "Configuration and Registration" for the basic Account setting information. The following table lists the instruction of the field about the advanced Account Setting.

Field Name	Description
<i>UDP Keep-alive Message</i>	Defines whether to active the phone UDP Keep-alive mechanism. The default is Enabled.
<i>UDP Keep-alive Interval(seconds)</i>	This parameter specifies how often the phone will send a packet to the SIP server. Default is 30 seconds.
<i>Login Expire(seconds)</i>	This parameter specifies the time frequency that phone refreshes its registration. The default interval is 3600 seconds.
<i>Local SIP Port</i>	Local SIP port. The default value is 5060.
<i>RPort</i>	The parameter allows you configuring the proxy to send responses back to a particular address and port. The default is disabled.
<i>SIP Session Timer</i>	This document defines an extension to the Session Initiation Protocol (SIP). This extension allows for a periodic refresh of SIP sessions through a re-INVITE or UPDATE request. The refresh allows both user agents and proxies to determine if the SIP session is still active.
<i>Subscribe Period(seconds)</i>	This parameter could set the period of the subscription. The default value is 1800.
<i>DTMF Type</i>	Select the DTMF type.

You can only configure these settings via Web interface.

- 1) Choose Account.
- 2) Select the desired account.
- 3) Choose Advanced to do the relating settings.

Account		Account 1
UDP Keep-alive Message	Enabled	?
UDP Keep-alive Interval (seconds)	30	
Login Expire (seconds)	3600	?
Local SIP Port	5060	?
RPort	Disabled	?
SIP Session Timer (seconds) T1	0.5	?
SIP Session Timer (seconds)T2	4	
SIP Session Timer (seconds)T4	5	
Subscribe Period(seconds)	1800	?
DTMF Type	RFC2833	?
How to INFO DTMF	Disabled	
DTMF Payload (seconds)	101	
100 reliable retransmission	Disabled	?
Enable Precondition	Disabled	?
Subscribe Register	Disabled	?
Subscribe for MWI	Disabled	?
MWI Subscription Period (Scope:0~84600) (seconds)	3600	
Caller ID Header	FROM	?
Use Session Timer	Disabled	?
Session Timer(seconds)		?

You can consult your system administrator for more information.

## TLS

TLS(Transport Layer Security), an IETF standards track protocol (RFC 5246), was based on the earlier SSL specifications developed by Netscape Corporation.

Set Transport via wen interface:

- 1) Choose Account->Basic.
- 2) Choose Transport option, in the pull-down menu, you can choose the TLS option.
- 3) Click the Confirm button to save the change.

**Yealink** Log Off

**Account** Account 1

Register Status	Registered
Account Active	Enabled
Label	0599111
Display Name	0599111
Register Name	0599111
User Name	0599111
Password	*****
SIP Server	10.2.1.199
Enable Outbound Proxy Server	Disabled
Outbound Proxy Server	
Transport	UDP
Backup Outbound Proxy Server	
NAT Traversal	Disabled
STUN Server	
Voice Mail	
Proxy Require	
Anonymous Call	Off
On Code	
Off Code	
Anonymous Call Rejection	Off

**NOTE**

**Display Name**  
SIP service subscriber's name which will be used for Caller ID display.

**Register Name**  
SIP service subscriber's ID used for authentication.

**User Name**  
User account, provided by VoIP service provider.

**NAT Traversal**  
Defines the STUN server will be active or not.

**Proxy Require**  
A special parameter just for Nortel server. If you login to Nortel server, the value should be: com.nortelnetworks.firewall

**Codecs**  
Choose the codecs you want to use.

**Advanced**  
The Advanced parameters for administrator.

## DNS-SRV

If the SIP server cannot be used, the phone will be connected on the server which is available.

To set DNS-SRV via web interface:

- 1) Go to Account->Basic.
- 2) Choose Transport option, in the pull-down menu, you can choose the DNS-SRV option.
- 3) Click the Confirm button to save the change.

## Network Setting

Please refer to the previous part "[Network](#)" for more information about the WAN Port, PC Port, VLAN etc.

## LLDP

The Link Layer Discovery Protocol (LLDP) is a vendor-neutral Layer 2 protocol that allows a network device to advertise its identity and capabilities on the local network.

Enable LLDP function; the phone will go to switch to get related VLAN parameters automatically. (Synchronous with VLAN in switch)

To configure LLDP settings via Web interface:

- 1) Choose Network->Advanced->LLDP->Active option, in the pull-down menu, choose enable or disable this function.
- 2) Then enter the corresponding Packet Interval in Packet Interval field.
- 3) Choose enable or disable the Overwrite Network option.
- 4) Click the Confirm button to save the change.

The screenshot displays the Yealink web interface for configuring network settings. The 'Network' tab is selected, and the 'Advanced' sub-tab is active. The 'LLDP' section is expanded, showing settings for 'Active' (Disabled), 'Packet Interval' (120), 'VLAN' (WAN Port, PC Port), 'Port Link' (WAN Port Link, PC Port Link), 'VPN' (VPNActive, Upload VPN Config), 'Voice QoS' (Voice QoS, SIP QoS), and 'Local RTP Port'. A 'NOTE' section on the right provides definitions for VLAN, QoS, and Local RTP Port.

## Maintenance Tasks

### Administrator Mode

The phone allows two modes to configure the phone:

- User Mode
- Administrator Mode

Administrator mode grants unlimited access to the phone configuration on both Web and Phone interface. User Mode cannot set the following options: Advance settings of accounts, Advance settings of Network, Reset to Factory, other advance phone settings.

To logout via Web interface:

Click the Log Off button in the top right corner.

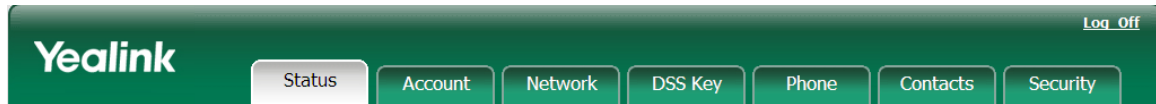

## Administrator/User Password

Administrator mode grants unlimited access to the phone configuration on both web and phone user interface. The administrator/user password is used to access:

- Web interface.
- The advance settings of the phone such as Network, Account via the Web and Phone interface.

The default administrator password is **admin**. Meanwhile the user name for Web interface access is **admin**.

To change the administrator password user can refer to "[SetPassword](#)".

## Reboot

You should reboot the phone when you are challenged, e.g. after applying changes to the phone configuration.

To reboot via Web interface:

- 1) Choose Phone->Upgrade.
- 2) Click Reboot button.
- 3) You are prompted to confirm the change, press Yes to confirm the changes, press No to cancel the operation.

### **Note:**

Any power interruption during the following process will most likely lead to a flash memory error which will cause system cannot boot up any more.

## Reset to Factory

You should reset the phone only in this case: the phone configuration was changed and the phone is not functioning anymore. To maintain the configuration of the phone, you need your system administrator or service provider's advice.

To reset to factory user can refer to "[Reset to factory](#)".

## Firmware Update

The phone is delivered with pre-installed firmware which allows operating your phone flawlessly. If you require updating the phone's firmware please contact your system administrator. You can only update the firmware via Web interface.

To update the firmware manually via Web interface:

- 1) Choose Phone->Upgrade, click the Browser button to select the firmware file in your local computer.
- 2) Click Upgrade button to update the new firmware.

To update the firmware automatically refer to "[Auto Provision](#)".

If the phone upgrade failed, the phone interface will show as below, you can obtain the IP address and then you can upgrade again via web interface.



- 1) Enter the IP address in the Web browser.
- 2) Enter into the upgrade interface.
- 3) Choose the firmware to upgrade again, or input the URL which is the firmware's server address.
- 4) Click the Upgrade or Confirm button to upgrade.

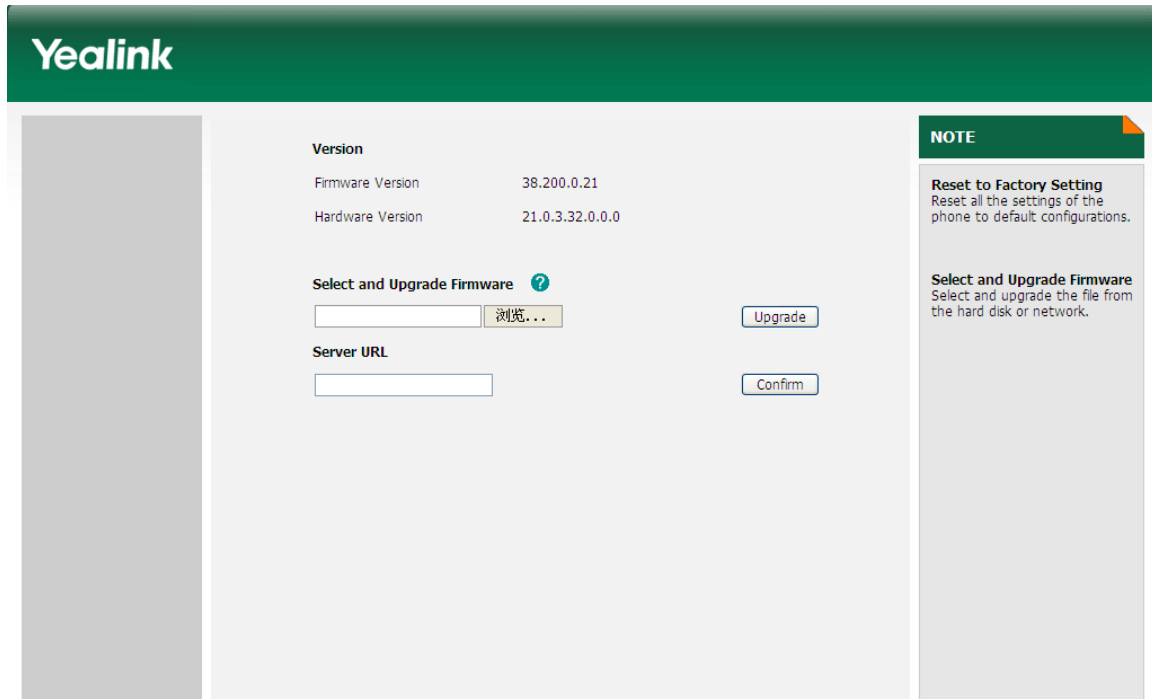

## Export / Import Config

To Export/Import the configuration file via Web interface:

- 1) Choose Upgrade->Configuration, select Export/Import Config, click Export button to export the file to your local computer.
- 2) Choose Upgrade->Configuration, select Export /Import Config, click Browse button, select the specific configuration file in your local computer, click Import button.

## System Log Export

If there are any errors happened in your phone, you can export the system log and send to your system administrator for diagnosis.

To export the System Log:

- 1) Choose Upgrade->Configuration, select Export System Log type, if the type is Local, it will export the syslog directly; if the type is server, it will export the syslog to the specified server.
- 2) Click Export button to export the file.

## PCAP Trace Export

The PCAP Trace used to record the data transport of your IP phone. If there are any errors happened in your phone, you can export the PCAP trace and send to your system administrator for diagnosis.



To export the PCAP Trace:

Choose Phone->Upgrade to enter, select Pcap Feature option, click Start button began to capture the trace, and click Stop to stop capture the trace, and then click Export to export the file to your local computer.

## Zero-sp-touch

Zero-sp-touch this function can help users to configure AUTOP and network parameters quickly.

Enable this function, when the power is on or press the corresponding DSSKEY, the phone will turn to the zero-sp-touch interface.

Turn on Zero-sp-touch when the power is on via web interface:

- 1) Choose Upgrade->Auto Provision, select ZeroActive option, in the pull-down menu, choose enable to turn on this function.
- 2) Enter the time in the Wait Time field.
- 3) Click Confirm button to save the changes.

The screenshot shows the Yealink web interface with the 'Auto Provision' configuration page. The 'ZeroActive' option is currently set to 'Disabled'. The 'WaitTime' is set to 5. The 'Day of week' section has checkboxes for all days of the week (Sunday through Saturday) which are all checked. A 'NOTE' box on the right side of the page states: 'Remote phone book. This feature allows you to download contact list from the server. Input the phonebook URL and rename the phonebook.'

Enter into zero-sp-touch interface, first a countdown interface comes into view.

- 1) No any operation or press cancel soft key, will enter idle interface.
- 2) Press status key enters into phone's network interface, can search the internet.
- 3) Press OK key, enter a network setting interface, press next key enter an AutoP setting interface, enter the corresponding contents; press OK key to save the settings. Press back key return to previous menu.

## DSS key Configuration

The phone has 10 Memory keys which are able to set up to 33 functions to per key. The following list shows the functions you can set on the Memory keys and provides a description for each function. The default configuration for each key is N/A which means the key hasn't been set for any functions.

- N/A
- [Line](#)
- [Speed Dial](#)
- [BLF](#)
- [BLF List](#)
- [Voice Mail](#)
- [Pick Up](#)
- [Group Pickup](#)
- [Call Park](#)
- [Intercom](#)
- [DTMF](#)
- [Prefix](#)
- [Local Group](#)
- [XML Group](#)
- [LDAP](#)
- [Broadsoft Group](#)
- [Conference](#)
- [Forward](#)
- [Transfer](#)
- [Hold](#)
- [DND](#)
- [Redial](#)
- [Call Return](#)
- [SMS](#)
- [Record](#)
- [URL Record](#)
- [Paging](#)
- [Group Listening](#)
- [Public Hold](#)
- [Private Hold](#)
- [Shared Line](#)
- [ACD](#)
- [Zero-sp-touch](#)
- [URL](#)

**Note:**

1. You have to pre-configure your PBX In order to apply quick access features like

Intercom and Voicemail on your phones. Please contact your system administrator for more information.

2. Users can also connect EXP38/EXP39 to extend the DSS keys to 48 or more.

## **Line**

You can set these keys as line keys to active up to the six user accounts.

To assign the key as Line:

Choose DSS Key->Memory Key or Line Key, choose one of the link key you want to make the assignment, there is a pull-down menu in the Type field, choose Line from the list, press Confirm button to save the changes.

## **Speed Dial**

You can configure the key as a simplified speed dial key. This key function allows you access the most frequently dialed numbers easily.

To assign the key as Speed Dial:

- 1) Choose DSS Key->Memory Key or Line Key, choose one of the keys you want to make the assignment, there is a pull-down menu in the Type field, choose Speed Dial from the list.
- 2) Enter the number you want to perform Speed Dial in the Value field.
- 3) In the "Line" field, select a line for which to apply this key.
- 4) Press Confirm button to save the changes.

## **BLF**

You can configure the key for Busy Lamp Field (BLF) which allows you to monitor the status (idle, ringing, or busy) of other SIP accounts. User can dial out on a BLF configured key.

To assign the key as BLF:

- 1) Choose DSS Key->Memory Key or Line Key, choose one of the keys you want to make the assignment, there is a pull-down menu in the Type field, and choose BLF from the list.
- 2) Enter the number you want to monitor in the Value field,
- 3) In the "Line" field, select a line for which to apply this key.
- 4) And then enter the feature codes in the extension field.
- 5) Press Confirm button to save the changes.

Please refer to "LED Instruction" for more details about the LED status in different situation.

### **Note:**

User can also set the pickup number to active the pickup function. For example, if you set the BLF number as 212, and the pickup number is \*83, then when there is an incoming call to 212, press the BLF key, it will call out the \*83 automatically to pickup the incoming call on 212.

## **BLF List**

BLF list is a function which can monitor the group status, it is not one to one monitoring, but the information feedback from the server to decide which BLF list will monitor which account.

To set BLF List via web interface:

- 1) Choose Account->Advanced-> BLF List URI, enter the BLF List URI.
- 2) Then enter the BLF List Code in the BLF List Code field.
- 3) Click the Confirm button to save.

To assign the key as BLF List:

- 1) Choose DSS Key->Memory Key or Line Key, choose one of the keys you want to make the assignment, there is a pull-down menu in the Type field, and choose BLF List from the list.
- 2) In the "Line" field, select a line for which to apply this key.
- 3) Press Confirm button to save the changes.

## **Voice Mail**

When the key is configured as Voicemail key you are allowed to access voicemail quickly by pressing this key.

To assign the key as Voice Mail:

- 1) Choose DSS Key->Memory Key or Line Key, choose one of the keys you want to make the assignment, there is a pull-down menu in the Type field, choose Voice Mail from the list.
- 2) Enter the number you want to set as the voice mail box in the Value field.
- 3) In the "Line" field, select a line for which to apply this key.
- 4) Press Confirm button to save the changes.

## **Pick Up**

When you configure a Pick Up key, you specify the extension that you want to monitor. Then, when the monitored extension receives a call, you can press this key to pick up the incoming calls.

To assign the key as Pick Up:

- 1) Choose DSS Key->Memory Key or Line Key, choose one of the keys you want to make the assignment, there is a pull-down menu in the Type field, choose Pick Up option from the list.
- 2) Enter the feature code (for example, input \*78345, \*78 is the feature code and the 345 is the extension number you want to pickup) in the Value field.
- 3) In the "Line" field, select a line for which to apply this key.
- 4) Press Confirm button to save the changes.

## **Group Pick up**

When you configure a Group Pick Up key, you specify the extension group that you want to monitor. Then, when the monitored group receives a call, you can press this key to

pick up the incoming call. If the group receives multiple calls simultaneously, you will pick up the specific one the server assigns to you.

To assign the key as Group Pick Up:

- 1) Choose DSS Key->Memory Key or Line Key, choose one of the keys you want to make the assignment, there is a pull-down menu in the Type field, and choose Group Pick Up option from the list.
- 2) Enter the feature code (for example,\*78) in the Value field.
- 3) In the "Line" field, select a line for which to apply this key.
- 4) Press Confirm button to save the changes.

## **Call Park**

Call Park is a feature that allows a person to put a call on hold at one telephone set and continue the conversation from any other telephone set.

The "call park" feature is activated by pressing a preprogrammed button or a special sequence of buttons. When the conversation which is monitored was transferred to an unused extension number, you can dial the feature code to retrieve the call.

To assign the key as Call Park:

- 1) Choose DSS Key->Memory Key or Line Key, choose one of the keys you want to make the assignment, there is a pull-down menu in the Type field, and choose Call Park from the list.
- 2) Enter the number you want to park in the Value field.
- 3) In the "Line" field, select a line for which to apply this key.
- 4) Press Confirm button to save the changes.

## **Intercom**

You can configure the key for Intercom mode and is useful in an office environment as a quick access to connect to the operator or the secretary.

To assign the key as Intercom:

- 1) Choose DSS Key->Memory Key or Line Key, choose one of the keys you want to make the assignment, there is a pull-down menu in the Type field, and choose Intercom from the list.
- 2) Enter the feature code and the intercom number you want to intercom in the Value field (for example: the feature code is \*87, the intercom number is 0599123, and then user must enter the \*870599123 in the value field.
- 3) In the "Line" field, select a line for which to apply this key, the default one is Line 1.
- 4) Press Confirm button to save the changes.

**Note:**

Your VoIP PBX must support this feature. And make sure the Intercom Allow is enable.

## **DTMF**

You are allowed to send out the desired DTMF number during the conversation. The number needs to be set in advance.

To assign the key as DTMF:

- 1) Choose DSS Key->Memory Key or Line Key, choose one of the keys you want to make the assignment, there is a pull-down menu in the Type field, choose DTMF from the list.
- 2) In the "Value" field, enter the specific number.
- 3) Press Confirm button to save the changes.

## **Prefix**

When you set up the function of prefix, press this key, the phone will be ready to make a new call, and show up the content which you're set previously on the dial interface. And you could enter other figure and call out

To assign the key as Prefix:

- 1) Choose DSS Key->Memory Key or Line Key, choose one of the keys you want to make the assignment, there is a pull-down menu in the Type field, and choose Prefix from the list, and enter the number you want to show up on the dial interface in the Value field.
- 2) Press Confirm button to save the changes

## **Local Group**

The keys can be configured as Local Group key. Then pressing this key under the idle status, you can enter the Local Group interface.

To assign the key as Local:

- 1) Choose DSS Key->Memory Key or Line Key, choose one of the keys you want to make the assignment, there is a pull-down menu in the Type field, and choose Local Group from the list.
- 2) In the Line field, choose a Contacts or group, if you want to select a group, you must add a group at first.
- 3) Press Confirm button to save the changes.

## **XML Group**

The keys can be configured as XML Group key. Then pressing this key under the idle status, you can enter the XML Group interface.

To assign the key as XML Group:

- 1) Choose DSS Key->Memory Key or Line Key, choose one of the keys you want to make the assignment, there is a pull-down menu in the Type field, and choose XML Group from the list.
- 2) In the Line field, choose a remote phone book to specify the record, so you must configure the remote phone book at first.
- 3) Press Confirm button to save the changes.

## **LDAP**

If you want to use the LDAP function, you must configure the corresponding options in the LDAP interface at first.

To assign the key as LDAP:

- 1) Choose DSS Key->Memory Key or Line Key, choose one of the keys you want to make the assignment, there is a pull-down menu in the Type field, and choose LDAP from the list.
- 2) Press Confirm button to save the changes.
- 3) When you press this key under the idle, the phone will turn to the contact search interface.

## **Broadsoft Group**

The keys can be configured as Broadsoft Group. Then pressing this key under the idle status, you can enter the Broadsoft Group interface.

To assign the key as Broadsoft Group:

- 1) Choose DSS Key->Memory Key or Line Key, choose one of the keys you want to make the assignment, there is a pull-down menu in the Type field, and choose Broadsoft Group from the list.
- 2) In the Line field, choose a broadsoft Group to specify the record, so you must configure the Broadsoft Group at first.
- 3) Press Confirm button to save the changes.

## **Conference**

You are allowed to configure the DSS key to be used as a conference key while remaining in the current call. This key allows a user on a call to conference another party while remaining in the conference.

To assign the key as Conference:

- 1) Choose DSS Key->Memory Key or Line Key, choose one of the keys you want to make the assignment, there is a pull-down menu in the Type field, choose Conference from the list.
- 2) Press Confirm button to save the changes.

## **Forward**

If the key is configured as Forward key, press this key under the idle status, the IP phone will turn to the forward page, and you can set the Forward to number, then when there is any call to the extension number will be forwarded to the set number automatically.

To assign the key as Forward:

- 1) Choose DSS Key->Memory Key or Line Key, choose one of the keys you want to make the assignment, there is a pull-down menu in the Type field, choose Forward from the list.
- 2) Enter the extension number you want to forward to in the Extension field.
- 3) Press Confirm button to save the changes.

## **Transfer**

You are able to configure the key as a transfer key to perform the Blind/Attended/Semi-Attended Transfer.

To assign the key as Transfer:

- 1) Choose DSS Key->Memory Key or Line Key, choose one of the keys you want to make the assignment, there is a pull-down menu in the Type field, and choose Transfer from the list.
- 2) Enter the Number in the "Value" field, when you are on a conversation, press this key, the phone will blind transfer to the number. Or you can leave it blank to set as the transfer button.
- 3) Press Confirm button to save the changes.

## **Hold**

The key can be configured as a hold key. You can use this key to hold and retrieve a call during the conversation.

To assign the key as Hold:

- 1) Choose DSS Key->Memory Key or Line Key, choose one of the keys you want to make the assignment, there is a pull-down menu in the Type field, choose Hold from the list.
- 2) Press Confirm button to save the changes.

## **DND**

If the key is configured as DND key, you are allowed to active the DND function immediately when you press it. Press it again to deactivate DND mode.

To assign the key as DND:

- 1) Choose DSS Key->Memory Key or Line Key, choose one of the keys you want to



make the assignment, there is a pull-down menu in the Type field, choose DND from the list.

- 2) Press Confirm button to save the changes.

## **Redial**

If the key is configured as Redial key, press this key under the idle status, it will enter the Dialed Calls interface, then you can choose a special line to call out by pressing the line keys.

To assign the key as Redial:

- 1) Choose DSS Key->Memory Key or Line Key, choose one of the keys you want to make the assignment, there is a pull-down menu in the Type field, choose Redial from the list.
- 2) Press Confirm button to save the changes.

## **Call Return**

When the key is configured as Call Return key you are allowed to dial out the last phone call you received.

To assign the key as Call Return:

- 1) Choose DSS Key->Memory Key or Line Key, choose one of the keys you want to make the assignment, there is a pull-down menu in the Type field, choose Call Return from the list.
- 2) Press Confirm button to save the changes.

## **SMS**

When the key is configured as SMS key you are allowed to access SMS quickly by pressing this key.

To assign the key as SMS:

- 1) Choose DSS Key->Memory Key or Line Key, choose one of the keys you want to make the assignment, there is a pull-down menu in the Type field, choose SMS from the list.
- 2) Press Confirm button to save the changes.

## **Record**

Call recording is a phone function to record the conversation in the process of dialogue. Using this feature, please pay attention to the maximum recording time and frequency in advance. Generally, it maybe a few minutes.

To assign the key as Record:

- 1) Choose DSS Key->Memory Key or Line Key, choose one of the keys you want to make the assignment, there is a pull-down menu in the Type field, choose Record option from the list.
- 2) Press Confirm button to save the changes.

## **URL Record**

During the conversation, pressing the type of DSS key, and then follow the voice prompts to achieve the call recording capability.

- 1) When you are on the conversation, pressing the DSS key to start the recording process in the current Call.
- 2) Enable the recording function, the recording icon will be flashing and the DSS Key light will blink green for the ongoing recording process.
- 3) Pressing the DSS key again to disable the recording function, and the flashing recording icon will be disappeared simultaneously.
- 4) Follow the voice prompts to listen to the recording.

To assign a DSS key as URL Record:

- 3) Chooses Key->Memory Key or Line Key, choose one of the keys you want to make the assignment, there is a pull-down menu in the Type field, choose URL Recorder from the list.
- 4) Enter the condition code in the Value field.
- 5) Press Confirm button to save the changes.

**Note:**

During a conversation, press this type of DSS key to start the recording process; if the other party hung up, your phone will turn to the idle status.

## **Paging**

You can configure the key as Paging key. When you press this key, the phone will dial the number out directly.

To assign the key as Paging:

- 1) Choose DSS Key->Memory Key or Line Key, choose one of the keys you want to make the assignment, there is a pull-down menu in the Type field, choose Paging option from the list.
- 2) Enter the number you want to dial out directly in the Value field.
- 3) In the "Line" field, select a line for which to apply this key.
- 4) Press Confirm button to save the changes.

## **Group Listening**

When the key is configured as Group Listening key, you are allowed to enable the Speakerphone and Handset/Headset mode at the same time. It is suitable for the group conversation which has more than one person at one side. You are able to speak and listen using handset/headset; meanwhile the others nearby can listen using speakerphone. You can get back to the previous mode by pressing the key again. (If the current mode is handset or headset, users can press the speaker button to open or close the group listening function)

To assign the key as Group Listening:

- 1) Choose DSS Key->Memory Key or Line Key, choose one of the keys you want to make the assignment, there is a pull-down menu in the Type field, and choose Group Listening from the list.
- 2) Press Confirm button to save the changes.

## **Public Hold**

The key can be configured as a public hold key. During a conversation, all members belonging to that particular BLA group can use this key to hold a call.

To assign the key as Public Hold:

- 1) Choose DSS Key->Memory Key or Line Key, choose one of the keys you want to make the assignment, there is a pull-down menu in the Type field, choose Public Hold from the list.
- 2) Press Confirm button to save the changes.

## **Private Hold**

The key can be configured as a private hold key. During a conversation, all members belonging to that particular BLA group can use this key to hold the call, but only the initiator can retrieve the call.

To assign the key as Private Hold:

- 1) Choose DSS Key->Memory Key or Line Key, choose one of the keys you want to make the assignment, there is a pull-down menu in the Type field, choose Private Hold from the list.
- 2) Press Confirm button to save the changes.

## **Shared Line**

The Shared Line Appearances (SLA, which is also named as BLA) feature allows subscribers to share SIP lines and also provides status monitoring of the shared line.

When a user places an outgoing call using such an appearance, all members belonging to that particular SLA group are notified of this usage and are blocked from using this line appearance until the line goes back to idle state or when the call is placed on hold. Similarly all members of the SLA group are notified of an incoming call and the call can be picked up on a line appearance associated with the SLA extension.

To assign the key as Shared Line:

- 1) Choose DSS Key->Memory Key or Line Key, choose one of the keys you want to make the assignment, there is a pull-down menu in the Type field, choose Shared Line from the list.
- 2) Enter the condition code in the Value field.
- 3) In the "Line" field, select a line for which to apply this key, the default one is Line 1.
- 4) Press Confirm button to save the changes.

## **ACD**

ACD(Automatic Call Distribution) is automatic call distribution equipment, is according specific Transfer Rules and distribution strategy to switch the access call to the right person.

Presses DSSKey, it will pop up a login box, enter the User ID and Password, click the Log In soft key.

Presses DSSKEY again enter to the ACD Status page, choose Available/Unavail to change the status.

You can also press LogOut soft key to logout.

When you status is Available, the calls will be directed to your phone. Or the status is unavailable. the calls will not be directed to your phone.

To assign the key as ACD:

- 1) Choose DSS Key->Memory Key or Line Key, choose one of the keys you want to make the assignment, there is a pull-down menu in the Type field, and choose ACD from the list.
- 2) In the "Line" field, select a line for which to apply this key.
- 3) Press Confirm button to save the changes

**Note:**

ACD is not available on all call servers. For more information, contact your system administrator.

## **Zero-sp-touch**

You can also press the DSSKey which set as the Zero-sp-touch. Then press the DSSKey, the phone will turn to the Zero-sp-touch interface.

To assign the key as Zero-sp-touch:

- 1) Choose DSS Key->Memory Key or Line Key, choose one of the keys you want to make the assignment, there is a pull-down menu in the Type field, and choose Zero-sp-touch from the list.
- 2) Press Confirm button to save the changes

## URL

If the key is configured as URL, then pressing this key, you can send HTTP requests to a web server.

To assign the key as URL:

- 1) Choose DSS Key->Memory Key, choose one of the keys you want to make the assignment, there is a pull-down menu in the Type field, and choose URL from the list.
- 2) Enter the number you want to set as URL in the Value field.
- 3) Press Confirm button to save the changes.

## Voice

To edit the Voice filed via Web interface:

- 1) Choose Phone->Voice.
- 2) Set the following parameters shown in the table.

<b>Parameter</b>	<b>Description</b>
<i>Echo canceller</i>	Defines whether to enable the echo canceller.
<i>VAD</i>	Voice activity detection (VAD), also known as speech activity detection or speech detection, is a technique used in speech processing in which the presence or absence of human speech is detected.
<i>CNG</i>	A comfort noise generator (CNG) is a program used to generate background noise for voice communications during periods of silence that occur during the course of conversation.
<i>JITTER BUFFER</i>	It is a shared data area where voice packets can be collected, stored, and sent to the voice processor in evenly.
<i>Type</i>	To choose the type of JITTER BUFFER, adaptive or Fixed.
<i>Delay</i>	To set the Min Delay, Max Delay and Normal Delay parameter.

- 3) Press Confirm button to save the changes, or press Cancel button to cancel the changes.

**Yealink** Log Off

Status Account Network DSS Key **Phone** Contacts Security

Preference  
Features  
Upgrade  
Auto Provision  
Configuration  
Dial Plan  
**Voice**  
Ring  
Tones  
SMS  
Action URL  
Softkey Layout

**Echo Cancellation** ?

Echo canceller  ?

VAD  ?

CNG  ?

**JITTER BUFFER** ?

Type  Adaptive  Fixed

Min Delay

Max Delay

Normal Delay

**NOTE**

**VAD:**  
Voice Activity Detection.

**CNG:**  
Comfort Noise Generation.

**JITTER BUFFER:**  
It is a shared data area where voice packets can be collected, stored, and sent to the voice processor in evenly.

## Ring

Users can group your contacts, and then set the ringing tone for each group.

To edit the Ring option via Web interface:

- 1) Choose Phone->Ring.
- 2) Internal Ringer Text: To set group name. For example: family.
- 3) Internal Ringer File: To choose a special ring tone for the group.
- 4) Click the Confirm button to save the changes.

Internal Ringer Text	Internal Ringer File
1	Ring1.wav
2	Ring1.wav
3	Ring1.wav
4	Ring1.wav
5	Ring1.wav
6	Ring1.wav
7	Ring1.wav
8	Ring1.wav
9	Ring1.wav

## Tone Settings

You can use the country tone, or if you don't want to use the default one, you can custom it by yourself.

You can define the frequency and time period of all the following tones:

- Dial
- Ring Back
- Busy
- Congestion
- Call Waiting
- Dial Recall
- Record
- Info
- Stutter
- Message
- Auto Answer

To edit the tone filed via Web interface:

- 1) Choose Phone->Tones.
- 2) Enter the frequency and time period(in ms) as the following format:  
Frequency /Time Period (for example 400/200).
- 3) Press Confirm button to save the changes, or Cancel to cancel the change.

Log Off

# Yealink

Status Account Network DSS Key Phone Contacts Security

Preference  
Features  
Upgrade  
Auto Provision  
Configuration  
Dial Plan  
Voice  
Ring  
Tones  
SMS  
Action URL  
Softkey Layout

Select country: Custom

Dial:

Ring Back:

Busy:

Congestion:

Call Waiting:

Dial Recall:

Record:

Info:

Stutter:

Message:

Auto Answer:

Confirm Cancel

**NOTE**  
**Select Country**  
Choose the country you are in.  
In custom mode, you can write the tones manually in this format:element : [1]freq [+freq2][duration]

**Note:**

1. Please contact your system administrator for more information about the frequency and time period parameters. You can enter up to 8 groups for each tone.
2. If the frequency is set as 0, it means silence.



# Trouble Shooting

## **I can not register to the server?**

- 1) Check the IP address. If you set your WAN port in DHCP mode, please make sure that your DHCP server is on.
- 2) Check your gateway.
- 3) Check your DNS server.
- 4) Make sure your account information is the same as you have got from your ISP.
- 5) Check whether the SIP server is on.
- 6) Check the SIP register port, the default value is 5060.

## **I can't get the IP address?**

- Make sure you have plugged the Ethernet cable into the WAN port.
- Make sure that the DHCP server is on, and there are available IP addresses in the server.
- Try to set your WAN port to static IP client mode.

## **During a call, I can not hear any voice?**

Make sure your handset is tightly connected with the phone.

Check whether you have muted the conversation or not.

Consult the outbound server details with your ISP.

## **Have DTMF problem?**

Check which kind of DTMF you are using, and whether it is compatible with the server.

- Consult the payload value with your ISP.

## **How to change the time?**

Select the time zone or enter the time information manually on the webpage or the phone.

## **How to answer the incoming calls during a call?**

If a call comes in when you are in a conversation, press the navigation keys to switch to the incoming call interface, then press the Answer key or Speaker button to answer it.

## **How to refuse incoming calls during a call?**

You can turn off the function of call waiting, and then our phone will refuse all the incoming calls when you are in a conversation.

## **How to send SMS?**

You could edit the SMS in the Menu-> Messages->Text Messages.

**Note:**

Make sure that the SIP server you have registered supports SMS function.

**How to update the firmware?**

- 1) Enter the webpage of your phone, go to Upgrade, then you can find the option "Select and Upgrade Firmware" at the bottom of the page.
- 2) Select the file to update, and then click the Upgrade button.

**Note:**

Make sure the firmware you choose is provided by your service provider, or the device will probably crash after the update.

The manual is only for reference; please take the object as the standard.

We reserve the right to improve or change the product and the user guide without notice.

You can download the latest user manuals from our website:

<http://www.yealink.com/index.php/Support>